

# Submerged Arc

Product and Procedure Selection

UHRHAN  
SCHWILL

# TABLE OF CONTENTS

## BROCHURE #

### I. SUBMERGED ARC WELDING PROCESSES

- |  |        |
|--|--------|
| 1. How to Make Single Electrode Submerged Arc Welds                | C5.600 |
| 2. LAC™ Low Alloy Cored Wire Submerged Arc                         | C5.610 |
| 3. Making Submerged Arc Welds in the Flat and Horizontal Positions | C5.620 |
| 4. How to Make Circumferential Welds                               | C5.630 |
| 5. Porosity  | C5.650 |
| 6. Storing and Redrying Submerged Arc Welding Fluxes               | C5.660 |

### II. SUBMERGED ARC WELDING EQUIPMENT

- |                                 |        |
|---------------------------------|--------|
| 1. Tiny Twinarc®                | E9.100 |
| 2. How to make Tandem Arc Welds | C5.640 |



## SECTION I.

- |  |        |
|--|--------|
| 1. How to Make Single Electrode Submerged Arc Welds                | C5.600 |
| 2. LAC™ Low Alloy Cored Wire Submerged Arc                         | C5.610 |
| 3. Making Submerged Arc Welds in the Flat and Horizontal Positions | C5.620 |
| 4. How to Make Circumferential Welds                               | C5.630 |
| 5. Porosity  | C5.650 |
| 6. Storing and Redrying Submerged Arc Welding Fluxes               | C5.660 |



# How to Make SINGLE ELECTRODE SUBMERGED ARC WELDS



## BASIC REQUIREMENTS FOR GOOD WELDS

Because many variables in design and fabrication and in-service conditions affect the results obtained in applying the information in this bulletin, the testing and serviceability of a product or structure are the responsibility of the builder/user.

### CLEANLINESS

Organic contaminants, (oil, grease, paint, etc.) rust and scale, or moisture can cause porosity. Weld joint contamination from zinc based or epoxy based primers may result in severe porosity due to the large volume of gases generated from these materials during welding. Therefore:

1. Use only clean, rust-free electrode.
2. Screen used flux to remove large particles of slag or other debris (K310 Flux Screen). If used flux is contaminated with excess fine mill scale, remove the mill scale with a Lincoln Magnetic Separator (K58).
3. Always remove heavy rust or scale from the joint and clean off oil, grease or moisture. If any contaminants are present, welding speeds slower than maximum must be used to permit gas to bubble out of the weld before it solidifies. Therefore, it is often most economical to degrease the joint area or drive off moisture with a preheating torch.

### JOINT DESIGN AND FIT-UP

Submerged arc is a deep penetrating process. To avoid burn-through, the plates being welded are generally either butted tightly together or a back-up or stringer pass is used. For basic joint design information, request a copy of bulletin S630.

Where gaps are encountered, alter the procedures to reduce penetration. Use lower currents, faster travel speeds, DC(-) (electrode negative) or longer stickout.

#### **⚠ WARNING**

Porosity may be encountered in submerged arc welds over multiple pass welds made with Innershield® electrodes. Therefore, only one stringer pass with Innershield electrode should be used in joints intended for completion with submerged arc.

### FLUX COVERAGE

Set the flux depth so the light of the arc reflects on the electrode. Less flux results in flash-through which is uncomfortable for the operator and can cause porosity. Excessively deep flux produces a narrow, humped bead.

#### **⚠ WARNING**

Viewing excessive or extended flash-through may result in severe arc burns. Proper procedure and eye-protection should be exercised.

In semiautomatic welding, flux coverage is automatically controlled by proper cone selection as described on page 7. In automatic welding flux depth is set by the distance between the discharge end of the flux tube and the work.

For applications like roundabouts, edge, or 3 o'clock position welds, a support may be needed to hold the flux around the arc while welding. It can be a piece of fire resistant material clamped to the nozzle or flux dams tacked or clamped to the work. The grains of flux surrounding the molten weld puddle must remain still in reference to the weld puddle until the weld metal has solidified.

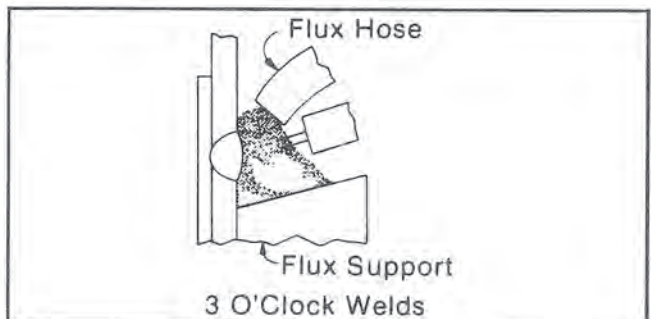
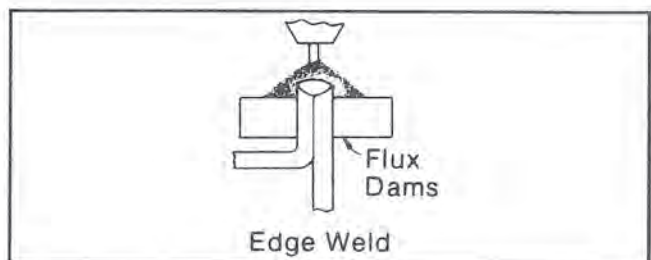
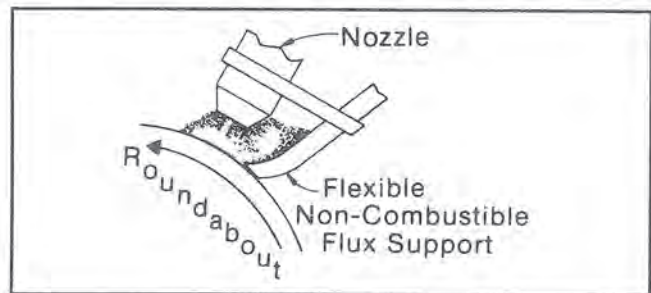

## WORK POSITION

Practically all submerged arc welding must be done with the work level. However, there are two cases where welding on inclined plates is advantageous:

1. On some sheet metal welds the speed can be increased by positioning the work for welding downhill. The maximum downhill angle is 25°
2. Heavy deep-groove welding is sometimes done at a 2-5° uphill angle. This helps keep the molten metal from running ahead of the arc.

## WELDING ROUNDABOUTS

The tendency for the flux and molten metal to spill off must be overcome when making circumferential or roundabout welds. Three factors are used:

1. The loose flux is supported (see page 1).
2. Bead size is limited by using low currents and fast travel.
3. The electrode displacement is adjusted so the weld solidifies as it passes vertical center. See below for recommended displacements.

For additional information about roundabout welding, see bulletin S632.

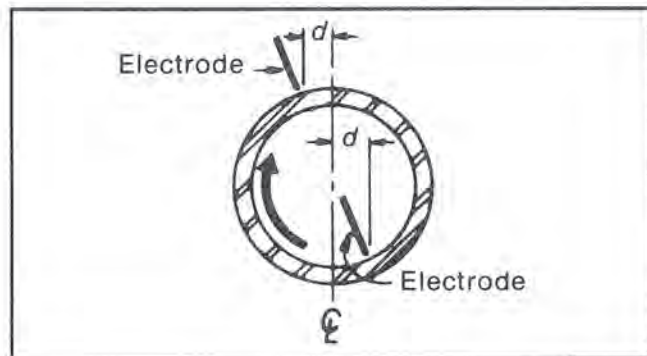

Diameter	
in.	mm
1 - 3	25 - 76
3 - 18	76 - 457
18 - 36	457 - 914
36 - 42	914 - 1067
42 - 48	1067 - 1219
48 - 72	1219 - 1829
Over 72	Over 1829

Displacement "d"	
in.	mm
3/8 - 3/4	9.5 - 19
3/4 - 1	19 - 25
1-1/4 - 1-1/2	32 - 38
1-1/2 - 1-3/4	38 - 44
1-3/4 - 2	44 - 51
2 - 2-1/2	51 - 64
3	64

## FLUX & ELECTRODE SELECTION

Lincoln electrodes and fluxes can generally be used in a wide variety of different applications. However, each has certain characteristics that influence weld quality or overcome specific problems. See bulletin S210 for up-to-date flux and electrode selection information.

## WORK LEAD CONNECTION LOCATION

Generally, best results are obtained by welding away from the work lead connection. Clamp the work lead directly to the work.

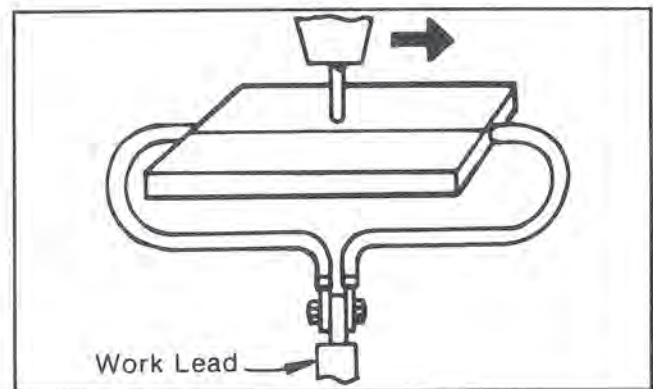
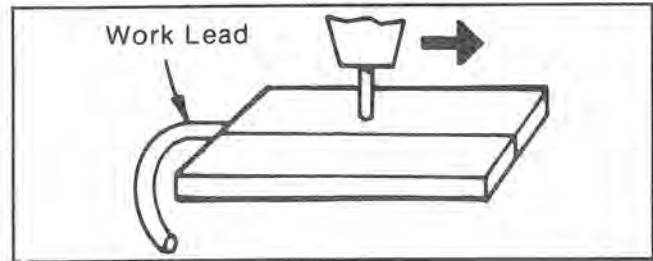

A poor location for the work lead connection can cause or increase arc blow and result in porosity and poor bead shape. Unfortunately it is not always possible to predict the effect and some experimenting may be necessary. In some cases, however, better results are obtained by splitting the work lead and connecting it to two or more places on the work.

## PREHEAT

Preheat may be required when welding high strength steels. The amount of preheat needed increases with thicker plate, rigid joints, and higher carbon and alloy contents. On multiple pass welds, maintain an interpass temperature equal to the required preheat temperature until all passes are complete.

The minimum required preheat can be estimated using the preheat tables in AWS code D1.1 or the "Preheat and Interpass Temperature Calculator", WC-8, available from Lincoln for \$3.

## CURRENT (WIRE FEED SPEED)

If the other variables are held constant, changing current has the following effects:

1. Increasing current increases penetration and melt-off rate.
2. Excessively high currents produce an erratic arc, undercut, or a high narrow bead.
3. Excessively low currents produce an unstable arc.

## EFFECT OF OPERATING VARIABLES

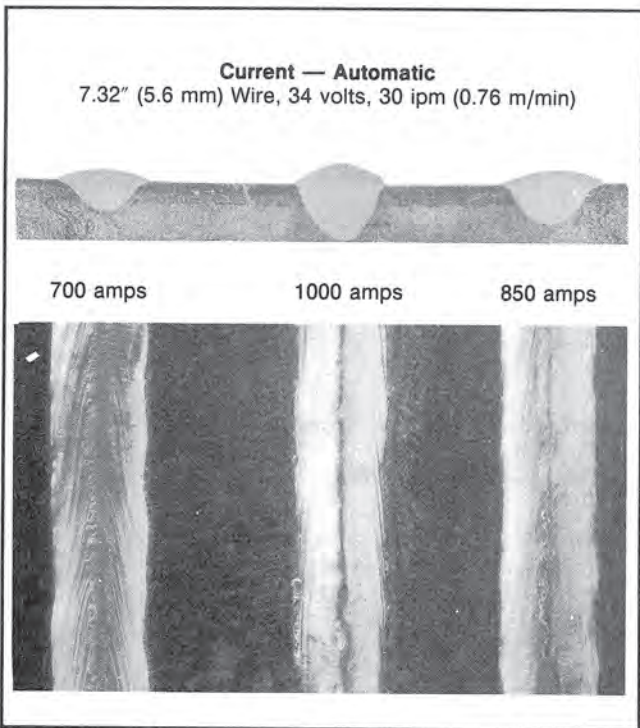
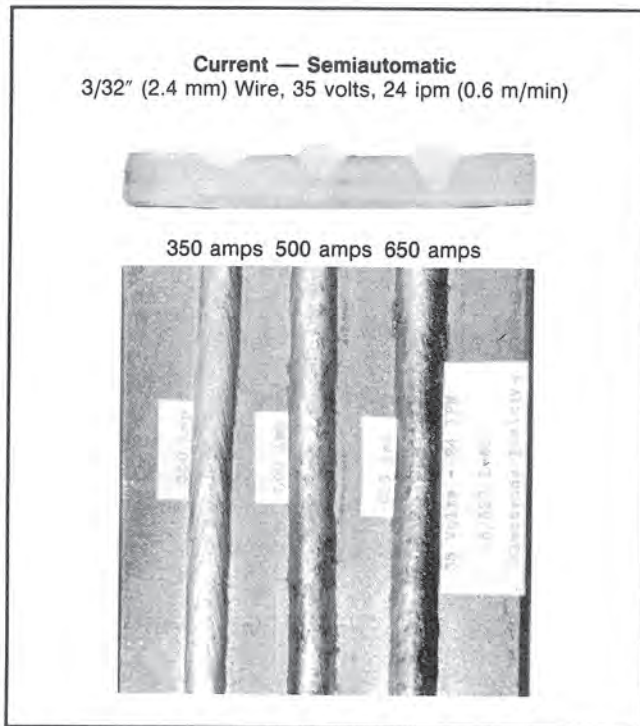

### TRAVEL SPEED

Changing the travel speed, like changing the current, will change weld size and penetration. Basically:

1. In single-pass welds, set the current and travel speed as high as possible and still get the correct weld size and desired penetration without burn-through.
2. For multiple-pass welds, set the travel speed to get the desired bead size.

If the other variables are held constant, changing travel speed has the following effects:

1. Excessively high travel speed decreases wetting action and increases the tendency for undercut, arc blow, porosity, and uneven bead shapes.
2. Slower travel speeds give gaseous material time to boil out of the molten weld, reducing the danger of porosity.
3. Excessively slow speeds produce:
  - a. "Hat-shaped" bead that is subject to cracking.

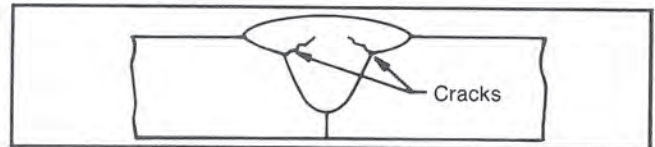

- b. Excessive flash-through which is uncomfortable for the operator. **Warning:** See Flux Coverage section on front page.
- c. A large molten pool that flows around the arc resulting in a rough bead, spatter and slag inclusions.
- d. Less penetration.

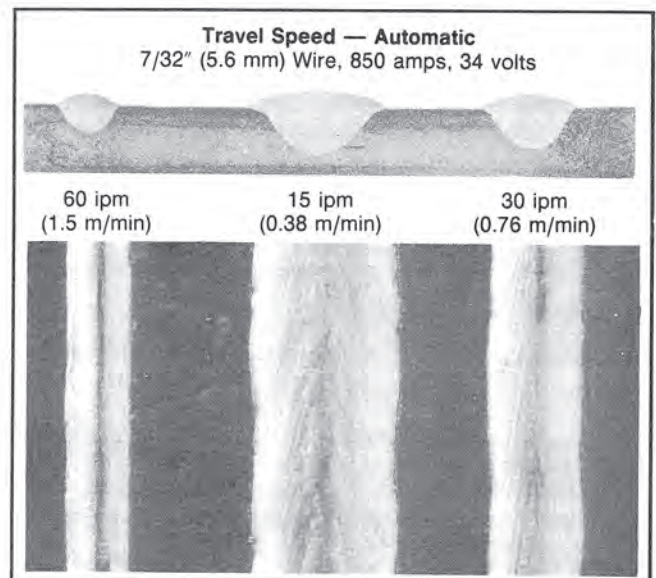
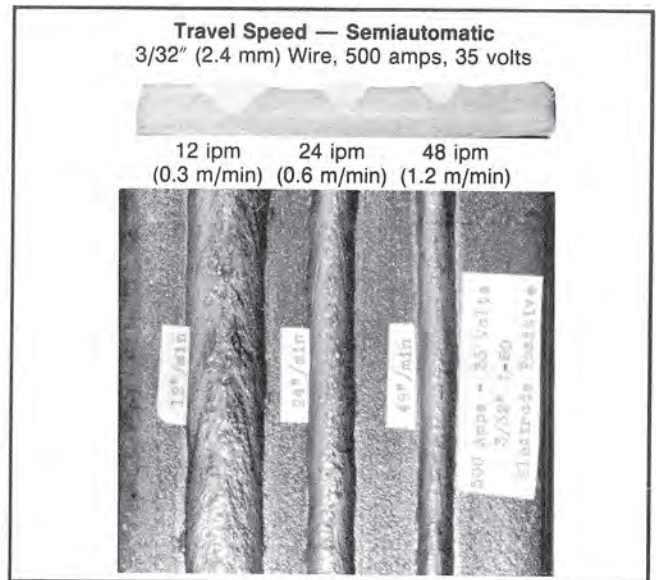



## ELECTRODE SIZE — SEMIAUTOMATIC WELDING

Guns, cables, drive rolls and guide tubes handle only a limited range of electrode sizes. Therefore, changing the electrode size often requires installation of proper parts for the wire size being used:

Only three different electrode sizes are used:

$1/16$ " (1.6 mm) electrode is used primarily for making high speed welds on 14 gauge to  $1/4$ " (1.9 to 6.4 mm) thick steel.

$5/64$ " (2.0 mm) electrode is used for welding 12 gauge (2.6 mm) and thicker material in most applications where the gun is hand-held.

$3/32$ " (2.4 mm) electrode is used in most applications where the gun is mechanically carried. It can be used for hand-held applications, but the stiff wire decreases flexibility of the cable and the larger molten pool requires extra operator skill.

1. Large electrodes handle higher currents.
2. Large electrodes at lower currents help bridge gaps when poor fit-up is encountered.
3. At a given current, reducing electrode size increases penetration and arc stability.
4. Small electrodes start easier.

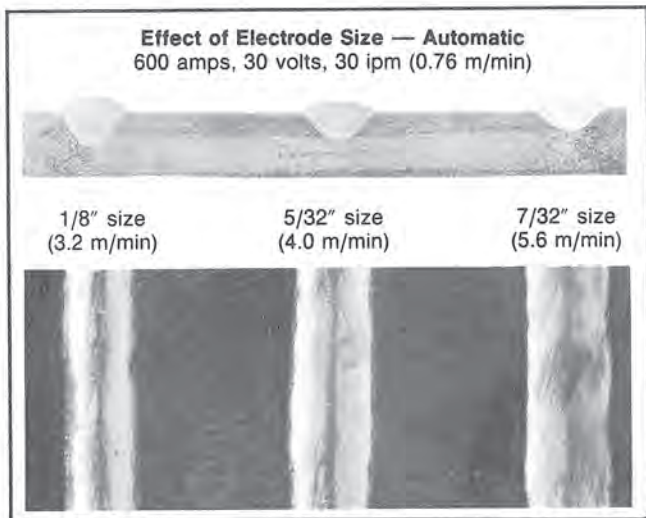

## VOLTAGE

Voltage is primarily used to control bead shape. If the other variables are held constant, changing voltage has the following effects:

1. Increasing voltage:
  - a. Produces a flatter and wider bead.
  - b. Improves slag removal on square edge butts and fillets.
  - c. Increases flux consumption.
  - d. Increases resistance to porosity caused by rust or scale.
  - e. Helps bridge gaps when fit-up is poor.
  - f. Increases pick-up of alloy from the flux. This can be used to advantage when welding with alloy or hardfacing fluxes to raise the alloy content of the weld. It can reduce ductility and increase crack sensitivity, particularly when making multipass welds.

For this reason the Lincoln "800 series" fluxes and 980 flux are recommended for multiple pass applications. The 800 series fluxes and 980 flux do not yield significant changes in alloy recovery with increasing voltage.

2. Excessively high voltages:
  - a. Produce a "hat-shaped" bead which is subject to cracking.
  - b. Produce poor slag removal.
  - c. In multiple pass welds, increase the alloy content producing a crack sensitive weld.
  - d. Produce a concave fillet weld which will be subject to cracking.
  - e. Decrease resistance to arc blow porosity.
3. Lowering the voltage produces a "stiffer" arc needed for getting penetration in a deep groove and to resist arc blow on high speed work. It also improves slag removal in deep groove welds.
4. An excessively low voltage produces a high, narrow bead with poor slag removal.

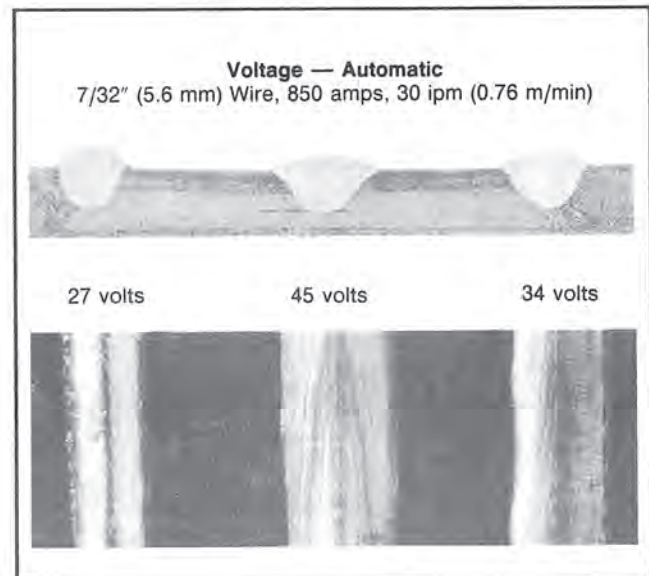
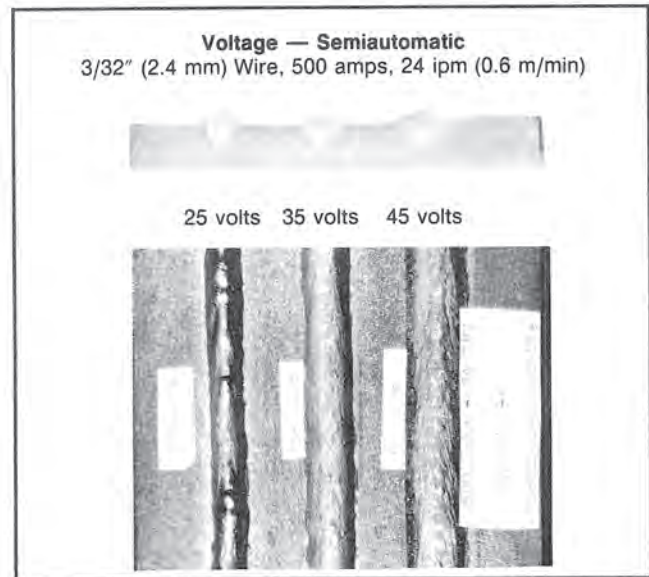

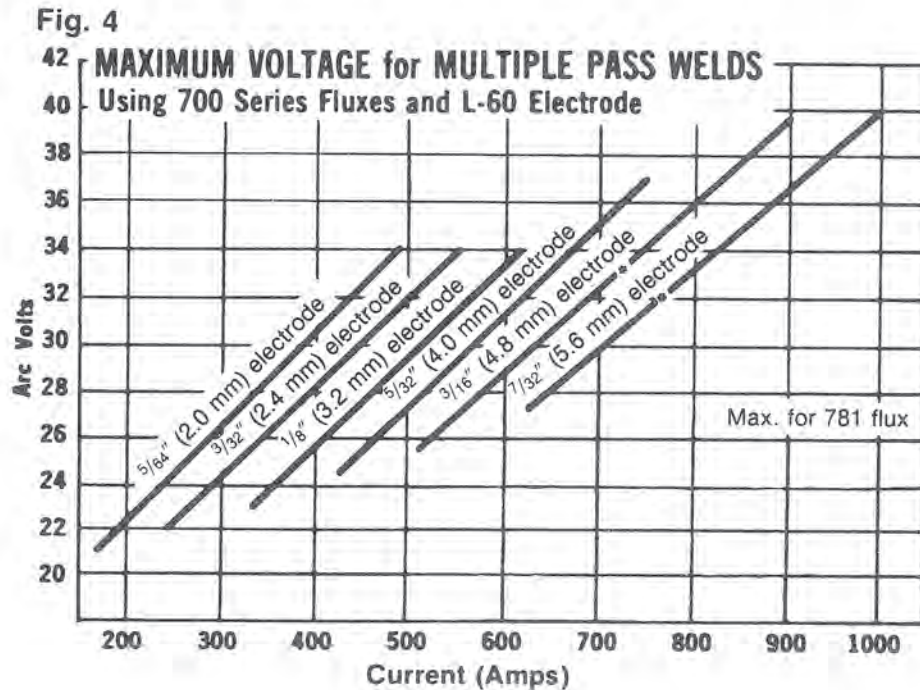

**MAXIMUM VOLTAGE FOR MULTIPLE PASS WELDS USING 700 SERIES FLUXES AND L-60 ELECTRODE**

Voltage must be limited to prevent silicon and manganese build up to prevent weld cracking and high cover pass hardness.

The curves in Figure 4 are for welding:

1. DC(+). For DC(-) increase by 4 volts.
2. 1 1/2" (38 mm) electrical stickout. For longer stickout, refer to section on Linc-Fill™ Extended Stickout Welding on page 8.
3. Plate under 1" (25 mm) thick.

**NOTE:** The voltages referred to in Figure 4 are actual arc voltages measured directly between the contact block and work during welding. When measuring arc voltage, some deviation or swing of the needle may occur depending upon the stability of the welding arc and the damping characteristics of the meter itself. The average reading is then accepted as the actual arc voltage.

These voltage limits apply to the following:

1. All Lincoln mild steel fluxes except 801, MIL 800, 860, 865, 880, 880M, 882, 980, 985 and 990M. Higher voltages can be used with the 800 series fluxes because they are neutral fluxes not sensitive to alloy pick-up.
2. L-60 electrode. The 700 series fluxes with L-60 electrode can be used for welding plate up to 1" (25 mm) thick provided that the voltage used does not exceed that given by the curves in Figure 4. Plates up to 1 1/2" (38 mm) thick welded in three o'clock position equally from both sides with a "700 series" flux and L-60 electrode require no special precautions. For multiple pass welding with L-61 electrode use 860 or 882 flux.
3. DC (+) (electrode positive), 1 1/2" (38 mm) electrical stickout. For DC (-) increase voltage by about 4 volts. For stickouts longer than 1 1/2" (38 mm), increase the voltage setting per Figure 5 below. This voltage increase will not increase alloy pickup in the weld metal.

**Fig. 5**

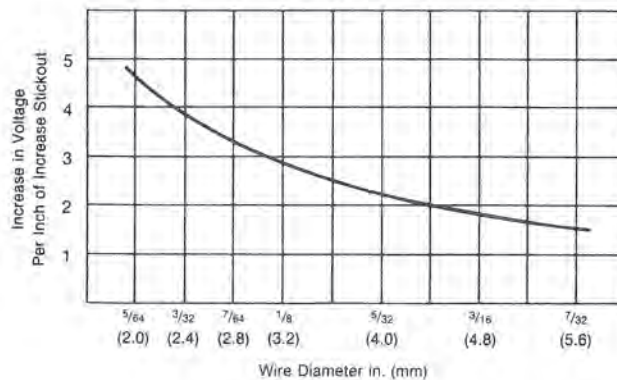

## POLARITY: DC(+) VS. DC(-)

DC(+) is recommended for most applications because it produces smooth welds and has greater penetration. It also has better resistance to porosity except on high sulfur and high phosphorous steel.

DC(-) has about  $\frac{1}{3}$  greater melt-off rate and less penetration. It is used:

1. For conventional fillets where the plate is clean and free of rust.
2. On applications where greater melt-off is beneficial such as hard-facing.
3. Where less penetration is needed to reduce admixture to control cracking or porosity on hard to weld steels.
4. Where greater build up and less penetration helps to prevent cracking in the first passes in deep groove work.
5. For Linc-Fill™ applications, (see page 8).

When changing from DC(+) to DC(-) at the same current, increase the voltage about 4 volts to maintain a similar bead shape.

## PENETRATION FILLETS: DC(+) VS. DC(-)

Deep penetration DC(+) fillets can reduce weld costs below conventional DC(-) fillets.

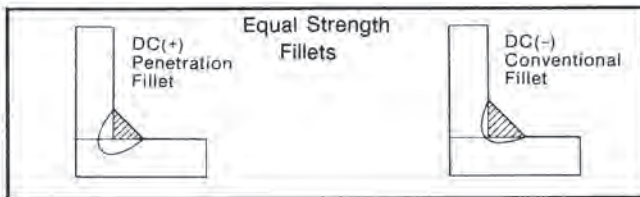

## OPERATOR TECHNIQUES — SEMIAUTOMATIC WELDING

### WIRE FEEDER

When properly adjusted, the drive rolls in Lincoln semiautomatic wire feeders slip before the electrode is forced into the cable and jammed. If the drive rolls are slipping, do not increase the roll pressure beyond the recommended setting. Find and correct the reason the electrode requires a greater than normal pushing force.

When installing new equipment or changing electrode size:

1. Be sure the drive rolls and wire guide tubes will handle the electrode size.
2. Adjust drive roll pressure for the electrode size.

Keep the wire feed mechanism clean. See the wire feeder Operating Manual for specific control adjustments and maintenance instructions.

Be sure the wire feeder and power source are set for either constant current or constant voltage as appropriate. Much submerged arc work is done with constant current power sources. Constant voltage is sometimes used for making small welds at very high travel speeds. Many of the newer power sources have a constant current, a constant voltage and a special constant voltage sub arc mode. Generally, constant voltage is used for making small welds, constant voltage sub arc is used for making small and large welds and constant current is used to make large flat welds.

The strength of a fillet depends upon effective throat size.

Throat size of a conventional fillet is determined by measuring with a fillet gauge. For equal fillets, throat is .707 times the leg size. If the legs are unequal, measure the smaller leg and multiply by .707. This method assumes the fillet penetrates just to the corner of the joint.

The throat of the penetration type fillet includes the weld metal added to the outside of the joint plus the penetration beyond the corner. Thus a small weld with deep penetration can have the same strength as a large fillet weld built up on the outside. A smaller weld size means lower weld costs.

### ELECTRODE STICKOUT

For a specific current, increasing the distance between the nozzle contact tip and the work increases the electrode melt-off rate. For additional information for both automatic and semiautomatic welding, see "Linc-Fill Extended Stickout Welding" on page 8.

### AC WELDING

AC is recommended for two specific automatic applications:

1. For the trail electrodes when tandem arc welding.
2. Occasional single arc applications where arc blow cannot be overcome by readjusting ground location.

For good arc stability a higher current density is needed for AC than for DC. When unstable arc conditions occur, increase the current or use the next smaller electrode size at the same current.

### GUN & CABLE HANDLING

1. When installing new equipment or changing electrode size, be sure the gun, cable and nozzle contact tip will handle the electrode size.
2. Do not kink or pull the cable around sharp corners.
3. Do not allow dolly wheels or trucks to run over the cable.
4. Keep the cable clean per instructions in the wire feeder Operating Manual.

### STARTING THE ARC

With a pair of diagonal cutters or side cutters clip the end of the electrode to a sharp point even with the end of the flux cone tip. Improperly clipped electrode may result in poor starts and arcing of the contact tip. Do not let the clipped end fall back into the gun.

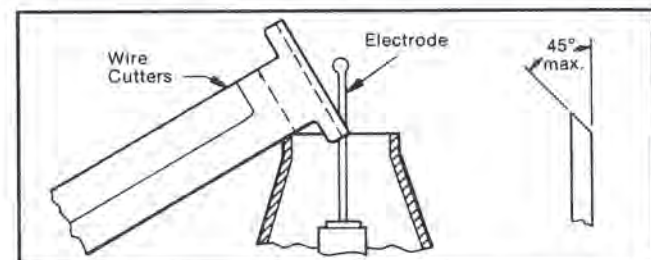

Set the current and voltage as needed for the specific job.

With disconnected LN-8 or LN-9 wire feeders, set the inch speed for the slow rate. If the arc flutters on and off, increase the inch speed. If inch speed is too fast, the wire will tend to stick on starting.

Position the gun over the joint as described under "Gun Operating Positions". Allow the mound of flux to form. Press the trigger and touch the electrode to the work by lightly scratching through the flux.

If the electrode hits the work, pushing the gun up without starting the arc, immediately release the trigger, raise the gun, and turn the nozzle up. Be sure the work lead makes a good connection and the work is clean at the starting point. Clip the electrode end and try again.

## GUN OPERATING POSITIONS

### HAND-HELD GUNS K113

Hold the gun handle parallel to the joint, with the gun barrel not greater than 45° from the vertical. With the flux cone tip lightly touching the work, press the trigger and proceed with the weld, lightly dragging the flux cone tip on the work.

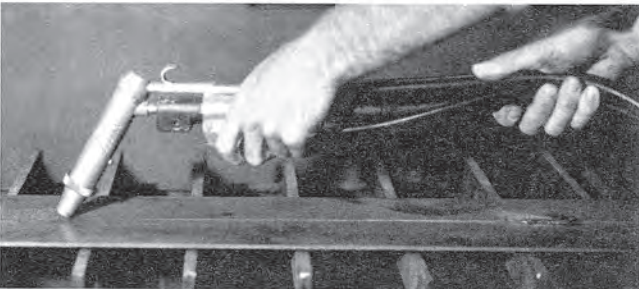
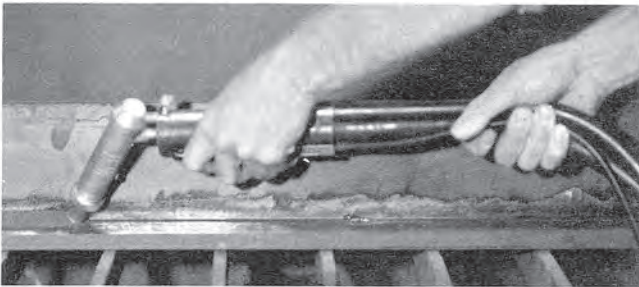

Hold the trigger in until the weld is finished. Release the trigger to stop the arc. At the same time lift the gun from the work and turn the nozzle up to stop the flux flow. Always set the gun down with the nozzle up to avoid wasting flux.

The LN-8 and LN-9 wire feeders are equipped with a "Trigger Interlock" switch. When this switch is turned "On" the trigger can be released after the arc is started.

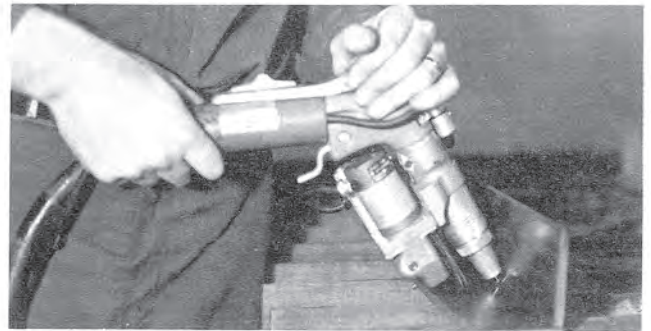
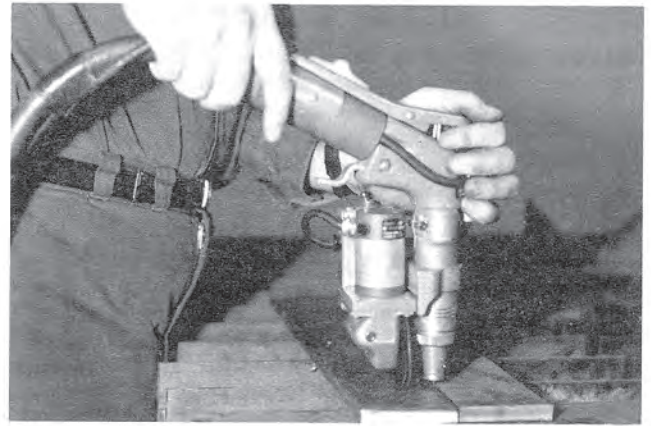

### MECHANIZED WELDING GUN (K114)

Hold the gun in the position shown in the photos above with the electrode perpendicular to the joint. Additional details for a range of joints are given in the LN-8 and LN-9 wire feeder Operating Manuals. Although the gun is designed to be travelled at a preset travel speed on the motor-driven wheel, it can also be hand travelled. For proper flux feeding the same gun positions should be maintained when it is hand carried.

### NOZZLE FLUX CONE

A series of flux cone tips with different diameter openings are shipped with each gun. The cone tip automatically establishes proper flux coverage when using the drag technique that is recommended for most joints.

In general, use the smallest cone tip that will provide sufficient flux coverage to avoid flash-through and permit making the desired size weld. The smaller the cone tip, the more positive the alignment of the wire with the seam. This is particularly important when making small high speed welds. If greater flux coverage is needed, use the next larger cone tip.

## LINC-FILL™ EXTENDED STICKOUT WELDING

Using the Linc-Fill extension guide increases the electrical stickout. The welding current passing through the longer length of electrode preheats the wire so it melts more quickly in the arc. This increases deposition rates for reduced weld costs.

Electrical stickout is the distance between the contact tip and the work as illustrated below:

For semiautomatic welding, an electrical stickout of  $\frac{3}{8}$ - $1\frac{1}{8}$ " (16-28 mm) is typical. This stickout is automatically set by using the appropriate flux cone size with the drag technique. Linc-Fill insulated extensions are available. They increase the electrical stickout to  $1\frac{3}{4}$  or 3" (44 or 75 mm), depending on the wire size and gun being used.

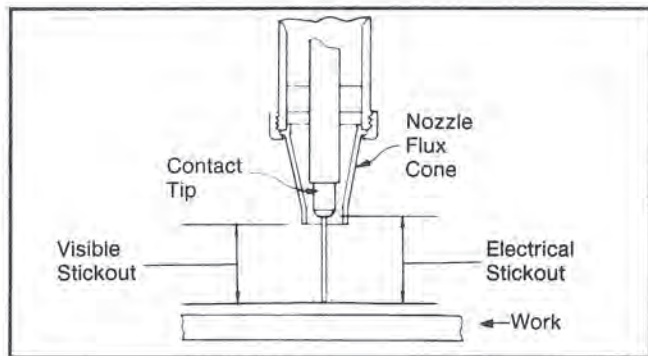

For full automatic welding, stickouts between  $\frac{5}{8}$  and 2" (16 and 50 mm) are normally recommended. Stickout is set by adjusting the distance between the contact tip and the work. For stickouts up to 5" (127 mm), Linc-Fill extension assemblies are available.

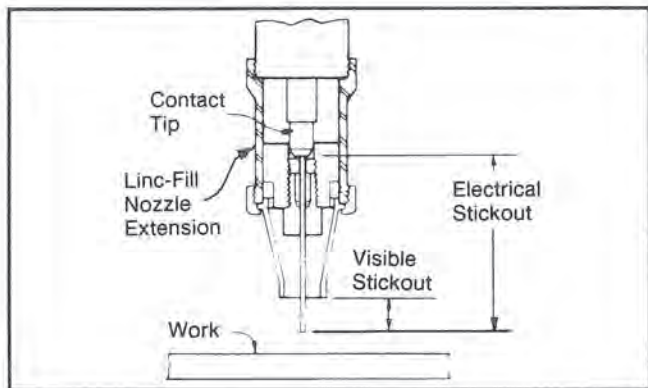

The advantages of using Linc-Fill extensions are shown in the graphs and charts on the following pages. These graphs and charts compare melt off rates of normal stickout and Linc-Fill extended stickout welding.



1/2" (12 mm) flat fillet welded at 540 amps at 15 in./min (0.38 m/min) with 3-1/4" (82 mm) stickout using a hand-held gun.

## LINC-FILL OPERATING TECHNIQUES

For reliable arc starting when using long stickout:

1. When automatic welding set the power source for an open circuit voltage comfortably above welding voltage. The optional start control for NA-3 or NA-5 will improve starting performance, and for especially difficult long stickout starting procedures, the Linc-Fill Starting Relay Kit (K237) may also be used.
2. Use a hot running start when full automatic welding.
3. When using discontinued ML-3, LN-4, LN-5 or LN-6 wire feeders, set the wire feeder for an inch speed of 50-70% of actual welding wire feed speed.
4. a. When using an LN-6 welder, install the special Linc-Fill starting kit, part number S14041.  
b. When using an LN-4 welder, connect the special time delay for reduced current starting. Set the power source for an open circuit voltage comfortably above welding voltage.
5. Generally, increase the voltage setting by 2 to 4 volts per inch of added stickout (see Figure 4).
6. Always clip the electrode to a sharp point (page 6).
7. When semiautomatic welding, start with a *light* moving scratch across the seam. With the LN-7, LN-8 or LN-9 have the electrode slightly off the work when the trigger is pressed.

## ELECTRODE MELT OFF RATES

(L-50, L-56, L-60, L-61, L-70, L-S3, LA-75, LA-90, LA-100)

The graphs on pages 9-10 compare melt off rates when welding with and without Linc-Fill Extended Stickouts. Information for these graphs was taken from the charts on pages 11-12.

**MELT OFF RATE VS. WIRE FEED SPEED**  
 DC(+) Polarity, Single Arc, **Normal Stickout**  
 (melt off rates increase 30-50% on DC(-) polarity)

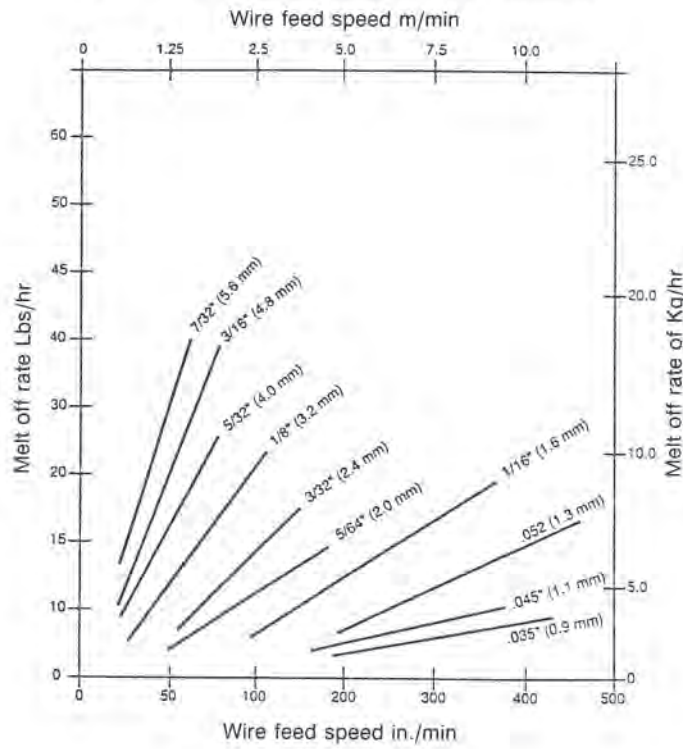

**MELT OFF RATE VS. WIRE FEED SPEED**  
 DC(-) Polarity, Single Arc, **Long Electrical Stickouts**  
 (on DC(-) melt off rates vary  $\pm 10\%$  with different fluxes)

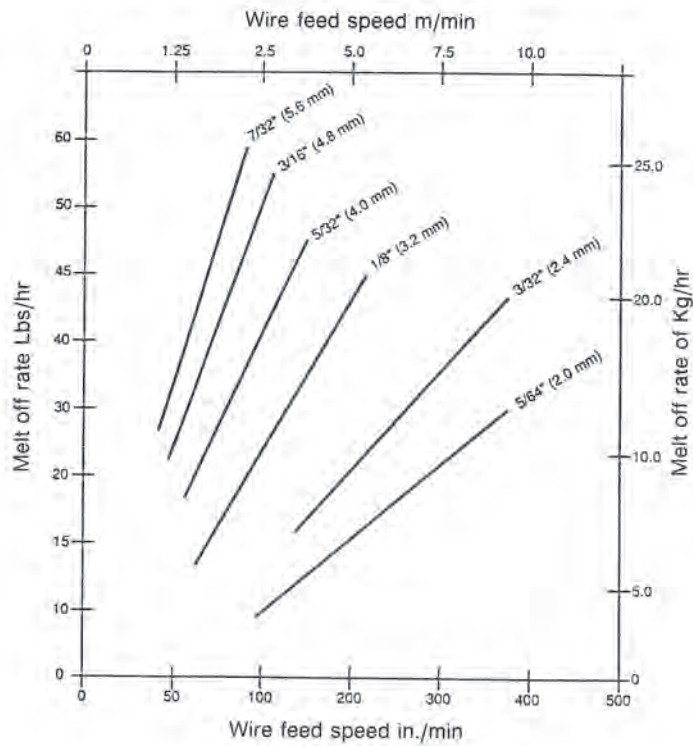

**CURRENT (AMPS) VS. WIRE FEED SPEED**  
 DC(+) Polarity, Single Arc, Normal Stickout

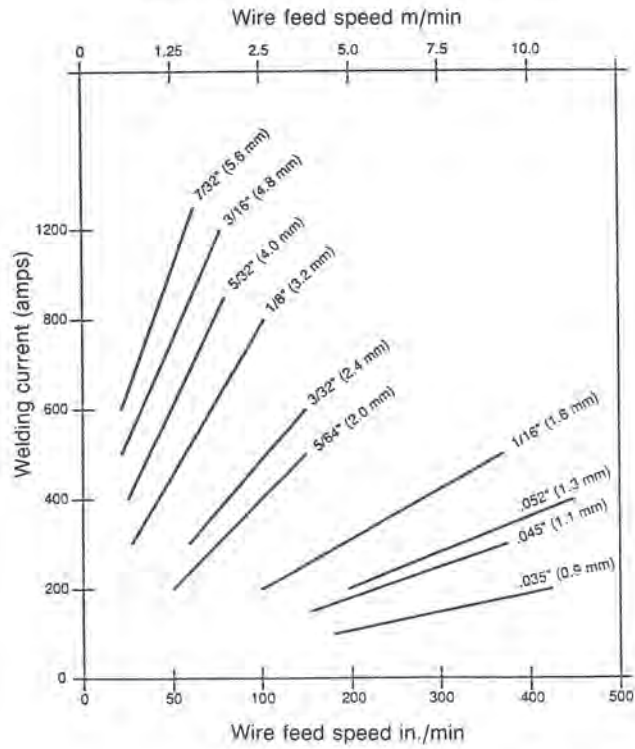

**CURRENT (AMPS) VS. WIRE FEED SPEED**  
 DC(-) Polarity, Single Arc, Long Electrical Stickout

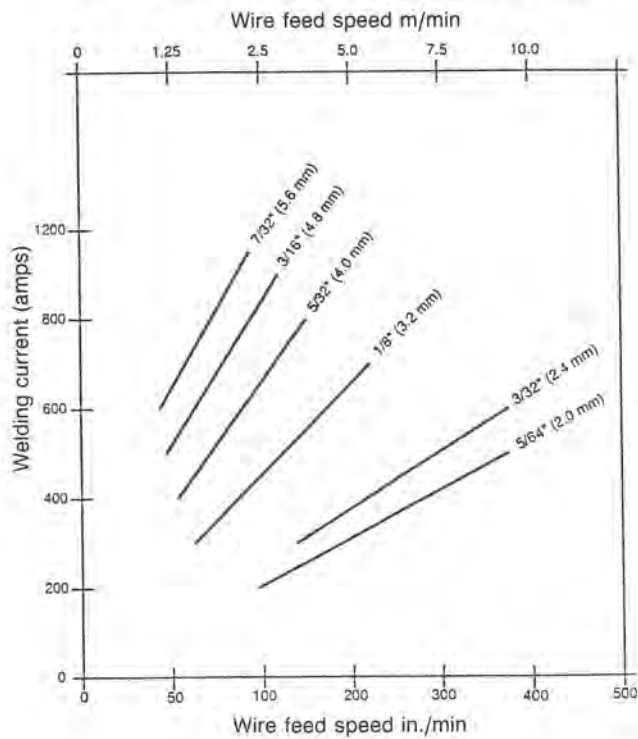

## ELECTRODE MELT OFF RATES (Customary Units) (L-50, L-56, L-60, L-61, L-70, L-S3, LA-75, LA-90, LA-100)

**DC(+) Polarity, Single Arc, Normal Stickout. Melt Off Rates Increase 30 – 50% on DC(–)**

Electrode Diameter (in.)	Normal Stickout (in.)	Melt Off	Amps													
			100	150	200	300	400	500	600	700	800	900	1000	1100	1200	1300
.035	1/2	in./min	185	296	428											
		lbs/hr	3.0	4.8	7.0											
.045	1/2	in./min		160	220	378										
		lbs/hr		4.3	5.9	10.2										
.052	1/2	in./min			190	304	458									
		lbs/hr			6.9	11.0	16.5									
1/16	5/8	in./min			98	165	251	369								
		lbs/hr			5.1	8.6	13.1	19.2								
5/64	1	in./min			50	84	123	181								
		lbs/hr			4.1	6.8	10.0	14.7								
3/32	1	in./min				57	82	112	150							
		lbs/hr				6.7	9.6	13.1	17.6							
1/8	1	in./min				27	40	55	71	90	112					
		lbs/hr				5.6	8.3	11.5	14.8	18.8	23.3					
5/32	1	in./min					24	34	45	56	68	81				
		lbs/hr					7.8	11.1	14.7	18.2	22.1	26.4				
3/16	1	in./min						22	29	37	45	53	62	72	82	
		lbs/hr						10.3	13.6	17.3	21.1	24.8	29.1	33.8	38.4	
7/32	1	in./min							21	26	31	36	42	48	55	63
		lbs/hr							13.4	16.6	19.8	23.0	26.8	30.6	35.1	40.2

**DC(–), Single Arc Long Electrical Stickouts. (On DC(–) Melt Off Rates Vary ±10% With Different Fluxes.)**

Electrode Diameter (in.)	Linc-Fill Extended Stickout (in.)	Melt Off	Amps													
			100	150	200	300	400	500	600	700	800	900	1000	1100	1200	1300
5/64	2-1/4	in./min			96	176	263	370								
		lbs/hr			7.8	14.3	21.4	30.1								
3/32	3-1/4	in./min				137	201	281	370							
		lbs/hr				16.1	23.6	32.9	43.4							
1/8	5	in./min				66	98	134	174	218						
		lbs/hr				13.8	20.4	27.9	36.3	45.4						
5/32	5	in./min					55	75	97	120	145					
		lbs/hr					17.9	24.4	31.6	39.1	47.2					
3/16	5	in./min						47	59	72	86	100	116			
		lbs/hr						22.0	27.7	33.8	40.3	46.9	54.4			
7/32	5	in./min							43	51	60	70	80	91		
		lbs/hr							27.4	32.5	38.3	44.7	51.1	58.1		

### Weight of Electrode (lbs/ft)

.035 — .0033	.052 — .0072	5/64" — .016	1/8" — .042	3/16" — .094
.045 — .0054	1/16" — .0100	3/32" — .023	5/32" — .065	7/32" — .128



# ELECTRODE MELT OFF RATES (Metric) (L-50, L-56, L-60, L-61, L-70, L-S3, LA-75, LA-90, LA-100)

DC(+) Polarity, Single Arc, Normal Stickout. Melt Off Rates Increase 30 – 50% on DC(–)

Electrode Diameter (mm)	Normal Stickout (mm)	Melt Off	Amps													
			100	150	200	300	400	500	600	700	800	900	1000	1100	1200	1300
0.9	12	m/min	4.7	7.5	10.9											
		kg/hr	1.4	2.2	3.2											
1.1	12	m/min		4.1	5.6	9.6										
		kg/hr		2.0	2.7	4.6										
1.3	12	m/min			4.8	7.7	11.6									
		kg/hr			3.1	5.0	7.5									
1.6	16	m/min			2.5	4.2	6.4	9.4								
		kg/hr			2.3	3.9	5.9	8.7								
2.0	25	m/min			1.3	2.1	3.1	4.6								
		kg/hr			1.9	3.0	4.5	6.7								
2.4	25	m/min				1.4	2.1	2.8	3.8							
		kg/hr				3.0	4.4	5.9	8.0							
3.2	25	m/min				0.7	1.0	1.4	1.8	2.3	2.8					
		kg/hr				2.5	3.8	5.2	6.7	8.5	10.6					
4.0	25	m/min					0.6	0.9	1.1	1.4	1.7	2.0				
		kg/hr					3.5	5.0	6.7	8.3	10.0	12.0				
4.8	25	m/min						0.6	0.7	0.9	1.1	1.3	1.6	1.8	2.1	
		kg/hr						4.7	6.2	7.8	9.6	11.2	13.2	15.3	17.4	
5.6	25	m/min							0.5	0.7	0.8	0.9	1.0	1.2	1.4	1.6
		kg/hr							6.1	7.5	9.0	10.4	12.2	13.9	15.9	18.2

DC(–), Single Arc, Long Electrical Stickouts. (On DC(–) Melt Off Rates Vary ±10% With Different Fluxes.)

Electrode Diameter (mm)	Linc-Fill Extended Stickout (mm)	Melt Off	Amps													
			100	150	200	300	400	500	600	700	800	900	1000	1100	1200	1300
2.0	57	m/min			2.4	4.5	6.7	9.4								
		kg/hr			3.5	6.5	9.7	13.7								
2.4	83	m/min				3.5	5.1	7.1	9.4							
		kg/hr				7.3	10.7	14.9	19.7							
3.2	127	m/min				1.7	2.5	3.4	4.4	5.5						
		kg/hr				6.3	9.3	12.7	16.5	20.6						
4.0	127	m/min					1.4	1.9	2.5	3.0	3.7					
		kg/hr					8.1	11.1	14.3	17.7	21.4					
4.8	127	m/min						1.2	1.5	1.8	2.2	2.5	2.9			
		kg/hr						10.0	12.6	15.3	18.3	21.3	24.7			
5.6	127	m/min							1.1	1.3	1.5	1.8	2.0	2.3		
		kg/hr							12.4	14.7	17.4	20.3	23.2	26.4		

### Weight of Electrode (g/m)

0.9 mm — 4.9	1.3 mm — 10.7	2.0 mm — 23.8	3.2 mm — 62.5	4.8 mm — 139.9
1.1 mm — 8.0	1.6 mm — 14.9	2.4 mm — 34.2	4.0 mm — 96.7	5.6 mm — 190.5



**THE  
LINCOLN ELECTRIC  
COMPANY**

DISTRIBUTED BY:

Local Sales and Service through Global Subsidiaries and Distributors  
Cleveland, Ohio 44117-1199 U.S.A.  
TEL: 216.481.8100  
FAX: 216.486.1751  
WEB SITE: www.lincolnelectric.com

**Submerged Arc  
C5.600 7/94**



**LINCOLN**<sup>®</sup>  
**ELECTRIC**

**LAC**<sup>™</sup>

## LOW ALLOY CORED WIRE SUBMERGED ARC

### — Selection and Use —



Increased deposition rates, improved impact properties, improved crack resistance and multiple arc procedures are some of the advantages of the LAC<sup>™</sup> system for low alloy submerged arc welding.

### GENERAL DESCRIPTION

The LAC low alloy submerged arc process is designed to replace solid alloy electrodes used with neutral fluxes. The LAC process consists of a series of LAC low alloy tubular electrodes which are used with Lincolnweld<sup>®</sup> 880, 882, 880M, MIL 800 or 980 flux. These fluxes are more neutral than most of the fluxes that are advertised as neutral. The advantages of the LAC low alloy process over solid alloy electrodes which are used with neutral fluxes are:

1. Deposition rates are as much as 50% greater at the same amperage, while maintaining a high impact level.
2. Less variation in the chemistry of the weld deposit when the voltage is varied.
3. Better impact properties in the HAZ due to the extended stickout procedures.
4. More resistance to weld cracking along with reduced penetration and less admixture at the same amperage with extended stickout procedures.
5. Better AC stability.
6. Better impact properties in the weld deposit made with tandem arcs.
7. More resistance to hot cracking.

### GENERAL DESCRIPTION OF ELECTRODES

These electrode-flux combinations are designated according to AWS A5.23-90, the "Specification for Low Alloy Steel Electrodes and Fluxes for Submerged Arc Welding."

**LAC-Ni2 (ECNi2)** — This electrode is designed to weld weathering steels (A588), 2½% Ni steels, 3½% Nickel steels and all other steels requiring 70,000 psi tensile (A.W. or S.R.) with low temperature impact requirements.

**LAC-M2 (ECM2)** — This electrode is designed to weld T1 and similar steels requiring 100,000 psi yield strength (A.W. or S.R.) and 15 ft-lbs minimum Charpy V-Notch at -50°F.

**LAC-B2 (ECB2)** — This electrode would be used to weld chrome-moly steels with 1¼% Cr, ½% Mo or less.

### DEPOSITION RATES

The following curves illustrate typical advantages in deposition rates of LAC electrodes versus low alloy welding with solid electrodes.

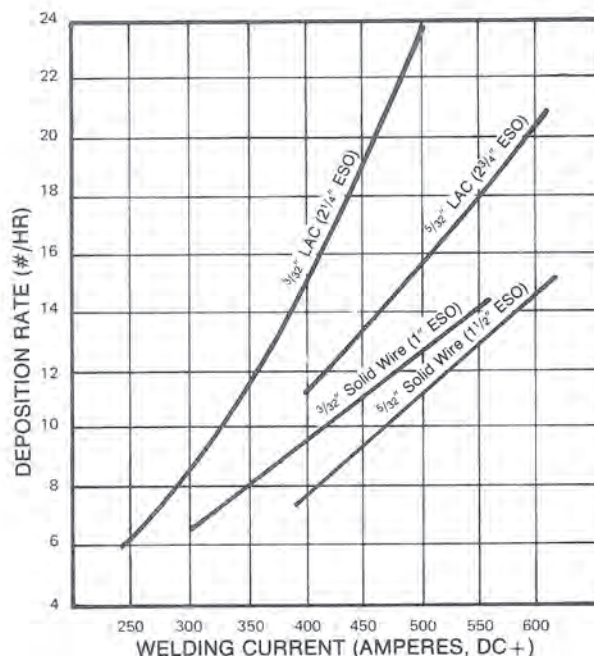

Figure 1

LAC electrodes exhibit a 40% to 50% increase in deposition rate when the recommended extended electrical stickouts are used over that obtained with solid alloy wires. It is usually not possible to increase the deposition rates of solid alloy wires by increasing electrical stickout without compromising weld deposit cleanliness and mechanical properties. With LAC electrodes, however, no deterioration of weld quality occurs when the recommended extended stickout procedures are used.

## MECHANICAL PROPERTIES

LAC electrodes Ni2, M2 and B2 with 800, 800M or LAC-M2 with MIL 800 flux as well as LAC-Ni2 with 882 or 980 flux meet the minimum requirements of AWS A5.23-90,

the "Specification for Low Alloy Steel Electrodes and Fluxes for Submerged Arc Welding."

The chemical and mechanical property requirements and test results are tabulated below:

**TYPICAL WELD METAL MECHANICAL PROPERTIES FOR RECOMMENDED LAC ELECTRODE FLUX COMBINATIONS**

Flux/Electrode	Condition	AWS-ASME Flux-Electrode Classification	Hardness Rb Average	Tensile Strength (ksi)	Yield Strength (ksi)	% Elongation In 2"	Charpy V-Notch Impact Strength	
							Test Temp.	Ft-Lbs Average
880/LAC-B2	S.R.	F8P2-ECB2-B2-H8	84	89.0	75.0	25	-20°F	48
880/LAC-M2	A.W.	F11A6-ECM2-M2-H8	100	111.0	100.0	25	-60°F	44
880/LAC-Ni2	A.W.	F7A6-ECNi2-Ni2-H8	87	81.0	65.0	30	-60°F	87
880/LAC-Ni2	S.R.	F7P10-ECNi2-Ni2-H8	84	78.0	62.0	31	-100°F	86
882/LAC-Ni2	A.W.	F8A4-ECNi2-Ni2	90	90.0	76.5	25	-40°F	60
882/LAC-Ni2	S.R.	F8P4-ECNi2-Ni2	87	84.0	70.0	29	-40°F	79
880M/LAC-B2	S.R.	F8P2-ECB2-B2-H8	91	87.0	73.0	25	-20°F	91
880M/LAC-M2	A.W.	F11A6-ECM2-M2	101	117.0	104.0	24	-60°F	53
880M/LAC-M2	S.R.	F11P6-ECM2-M2	100	114.0	100.0	24	-60°F	34
880M/LAC-Ni2	A.W.	F7A10-ECNi2-Ni2-H8	87	81.0	68.0	27	-100°F	65
880M/LAC-Ni2	S.R.	F7P10-ECNi2-Ni2-H8	84	78.0	64.0	32	-100°F	88
980/LAC-Ni2	A.W.	F8A2-ECNi2-Ni2-H8	93	92.0	80.0	27	-20°F	84
MIL 800/LAC-M2	A.W.	F11A6-ECM2-M2	102	120.0	107.0	23	-60°F	51

These are typical test results which were obtained from the welds made with the welding procedure shown below and tested in accordance with AWS A5.23-90.

### Test Procedures (For AWS A5.23-90)

(1/4" mechanical stickout) electrical stickout 2 3/4".

300°F preheat and interpass temperature.

5/32" diameter electrode at 500 amperes DC(+), 30 arc volts, 16 in./min travel speed.

Ni2 and B2 — Stress relieved @ 1150°F when specified.

Test Joint — LAC M2: A514, Type E (not buttered).

Test Joint — LAC Ni2: A36 plate buttered with Jet-LH8018-C1.

Test Joint — LAC B2: A36 plate buttered with Jetweld LH-90.

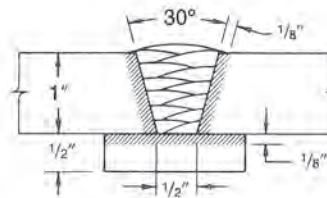
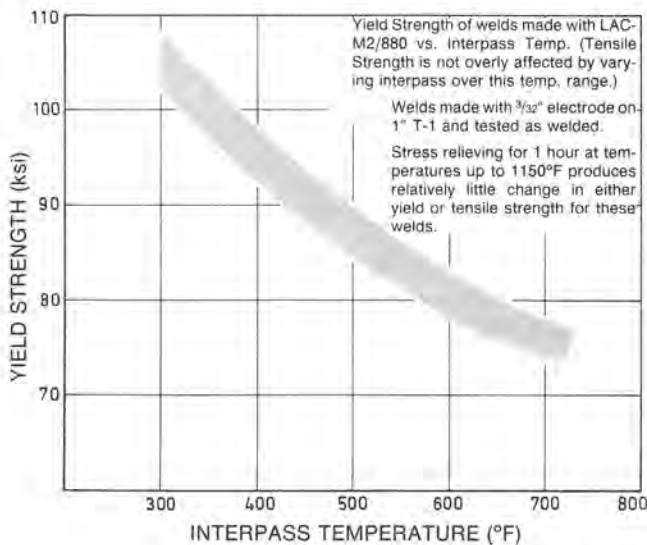

For split layers, locate the electrode 5/32" from the side wall to the edge of the electrode.

## EQUIPMENT

A Lincoln Submerged Arc Wire Feeding System with either a constant current or constant voltage power source is recommended.<sup>(1)</sup> The following equipment should be used:

### 1. For full automatic applications:

- M12908 wire reel mount with reel brake.
  - M10214 flux cored wire straightener.
  - K148A nozzle
  - K149-3/32 extension guide
  - S16167-3/32 guide tip
  - K148B nozzle
  - K149-5/32 extension guide
  - S13786-5/32 guide tip
- } For 3/32" LAC
- } For 5/32" LAC

### 2. For semiautomatic applications (5/32" dia.):

- K114 gun and cable assembly, S12891-1 extension guide.
- K113 gun and cable assembly, S13027-3 extension guide.

The recommended nozzles and wire straightener must be used to ensure proper electrical contact and consistent wire straightening.

With extended stickout full automatic procedures the use of the proper extension guides is recommended. These guides may be removed, however, when joint configuration limits accessibility.

## SELECTION: COMPARISON AND RECOMMENDATIONS FOR LAC™ LOW ALLOY SUBMERGED ARC WELDING

### MATCHED MECHANICAL PROPERTIES REQUIRED (Note E)

Type Steel		Recommended LAC Electrode/Flux	Recommended Post Heat Treatment	Notes
ASTM Grade and Class	Description			
A202-A, A302-A A203-A & B A352-LC2 A203-E A516-70 A537 — Class 1 A588 — All	Cr-Mn-Si, Mn-Mo  2½% Ni 3½% Ni C-Mn-Si C-Mn-Si Weathering Steel	LAC-Ni2/880, 880M, 882	A.W. or S.R. @ 1150°F  A.W. or S.R. @ 1100°F A.W. or S.R. @ 1100°F A.W. or S.R. @ 1100°F A.W. or S.R. @ 1150°F	C  C, D, H C, D, H
A514-A thru L A517-A thru L A533 — Class 2 & 3 A543 — Class 1 & 3 Class 2 (Note B)	Hi. Str. Quenched & Tempered Hi. Str. Quenched & Tempered Hi. Str. Quenched & Tempered Hi. Str. Quenched & Tempered	LAC-M2/880, 880M, MIL 800	A.W. or S.R. @ 1150°F A.W. or S.R. @ 1150°F A.W. or S.R. @ 1100°F A.W. or S.R. @ 1100°F	C, F C, F C, F C, F
A202-B	Cr-Mn-Si	LAC-B2/880, 880M	A.W. or S.R. @ 1150°F	C, F

### MATCHED CHEMICAL COMPOSITION REQUIRED

Type Steel		Recommended LAC Electrode/Flux	AWS A5.23 Classification (Note A)	Recommended Post Heat Treatment	Notes
ASTM Grade and Class	Description				
A387-2, A335-P2, A217-WC4, A182-F2	½ Cr, ½ Mo	LAC-B2/880	F8P2-ECB2-B2-H8	A.W. or S.R. (See Notes)	G
A182-F11 & F12, A335-P11 & P12, A387-11 & 12, A217- WC6, A234-WP11 & 12	1¼ Cr, ½ Mo	LAC-B2/880, 880M	F8P2-ECB2-B2-H8	A.W. or S.R. (See Notes)	G

#### NOTES:

- A The welding procedures, including post heat treatment, used to obtain the listed properties conform to the requirements of AWS A5.23. These procedures are shown on page 2 and discussed on pages 4 through 6.
- B For Class 2 limit heat input to 40,000 joules/in. to meet 115,000 psi tensile strength requirements.
- C First pass with low hydrogen stick electrode is recommended.
- D Weld metal over 2% Nickel is hot short and tends to crack. Therefore, always use low hydrogen hand electrode for the first one or two passes. Too high a preheat or interpass temperature will lower the impact properties. On thin plate where quench rates are low it is advisable to check the impact properties to verify conformance to requirements.
- E See page 2 for electrode/flux classifications.

When using a K148A nozzle, the K149-<sup>3</sup>/<sub>32</sub> extension guide is used with the S16167-<sup>3</sup>/<sub>32</sub> guide tip to give a 1¼" mechanical and a 2¼" electrical stickout. (The S16167-<sup>3</sup>/<sub>32</sub> is a special guide tip for <sup>3</sup>/<sub>32</sub>" LAC electrodes.)

During the initial setup of extended stickout procedures the extension guide should be removed. This will prevent damage due to poor starting prior to proper setup. With Lincoln constant current equipment, excellent starting is obtained with a cold start. If other equipment or constant voltage is used, the following conditions must be met to ensure good starting:

1. The electrode must be cut before each start.
2. The inching wire feed speed must be set below 60 in./min.
3. On constant voltage a hot start should be used and the electrode should be inched to approximately 1/8" above

the work before starting. The electrode should not touch the work.

### WORK PREPARATION

All the basic requirements for high quality submerged arc welding . . . position, joint design, cleanliness, backups, etc . . . must be met.

### WELDING PROCEDURE INFORMATION

**Precaution Note:** On welding applications subject to hydrogen-assisted HAZ or weld metal cracking, the use of extended stickout procedure with the LAC low alloy process is required. Elevated preheat and interpass temperatures may also be required to prevent hydrogen-assisted cracking on these applications.

<sup>(1)</sup> R3R power sources are not recommended for semiautomatic applications.

- F The HAZ properties of quenched and tempered steels seriously deteriorate if excessive welding heat input is employed. Most quenched and tempered steels are limited to a maximum heat input of 60,000 joules/inch. Where there is any question, the steel manufacturer should be consulted for exact heat input recommendations.
- G Weld strengths of Cr-Mo deposits decrease *substantially* with stress relieving temperatures over 1150°F. See Figure 2.
- H The optimum stress relieving temperature for the nickel deposits used to join A203-Grade E steel is 1100 ± 25°F. Nickel deposits stress relieved at temperatures below 1050°F or above 1150°F exhibit a severe loss of notch toughness at -150°F. (See Figure 3.)

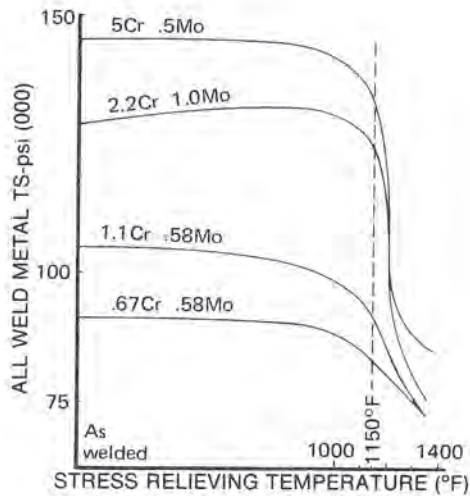

Figure 2

This critical response of nickel weld deposits to stress relieving temperature requires that proper controls be established to ensure that the stress relieving temperature is maintained within the desired range. Stress relieving furnaces should be calibrated to read weldment temperature, not furnace wall or furnace air temperatures.

The all weld metal chemistry deposited by the LAC low alloy process is unaffected by changes in the welding procedure. However, it is necessary in the welding of low alloy steels to employ low heat input procedures to maintain weld properties, HAZ properties, and to avoid cracks in the weld. The high heat input procedures often used to weld mild steel are not suitable for low alloy steels. The user must qualify his procedure to guarantee conformance to all requirements.

The LAC low alloy process is not intended for fast follow welding. This process is designed for plate welding of low alloy steels where weld quality and mechanical properties are the major considerations.

Your Lincoln representative has detailed procedures for some joints and alloys and these procedures should be used with the LAC low alloy process. Helpful procedural information is listed below:

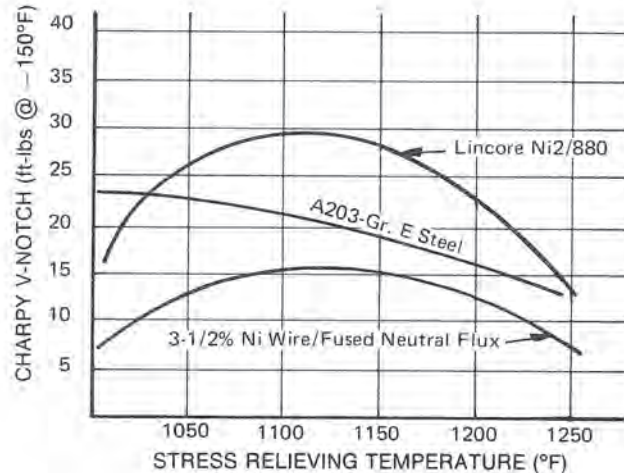

Figure 3

When strength only is required, fillet welds made on high strength low alloy (HSLA) steel can be made with lower strength filler metal provided that the fillet size is increased to provide the necessary strength. This is often a helpful procedure when welding HSLA steels which are sensitive to cracking.

For such applications 761 or 780 flux and L-61 electrode may be used for single pass fillets and 780 and L-60 for multiple pass fillets.

When welding with any flux electrode, the weld properties may vary depending upon (1) the chemistry of the plate, (2) rate of cooling, and (3) welding procedures. Therefore, the properties obtained with other tests and other procedures may be different from those obtained with the AWS test listed above. For this reason the fabricator has the responsibility to verify conformance to mechanical and/or chemical requirements on his application.

- I. The welding polarity on DC must be electrode positive. The high melt-off rate and "cold" puddle obtained on DC electrode negative does not allow for adequate fluxing of the weld puddle and therefore is not recommended. AC may also be used.
- II. One of the main difficulties in welding low alloy high strength steels is their sensitivity to hot cracking. This is especially true for steels containing over 2% nickel. The root of the weld is where cracking usually occurs and the bead shape is a contributing factor. Root cracking tendencies can be minimized by carefully following the guidelines listed below. These guidelines are not unique to LAC low alloy welding alone, but are accepted "good practice" throughout the welding industry for welding most low alloy steels.

1. Avoid root configuration that will result in a narrow and deep bead shape. The included angle should not be less than 60° when there is a 1/8" root opening and the included angle should not be less than 75° when there is no root opening.
2. Use manual electrodes for the first one or two passes in the root of the joint. The appropriate manual electrodes are shown below:

Jetweld® LH-110M for LAC-M2 applications.  
 Jet-LH® 8018-C3 for LAC-Ni2 applications.  
 Jetweld LH-90 for LAC-B2 applications.

3. Use the following recommended preheat and interbead temperatures:

Electrode	Plate Thickness Up to 1 1/2"	Plate Thickness 1 1/2" and Greater
LAC-M2	300°F	350°F
LAC-B2	250°F	350°F
LAC-Ni2	200°F	300°F

Lower or higher temperatures may be used as required by the actual job conditions and/or prevailing codes.

4. Use a low current and low travel speed procedure for the first two automatic passes made with the LAC electrodes. Some suggested procedures are:
  - a. 3/32" dia. @ 250 amps (+), 25 volts, 10 in./min with a 1" stickout.
  - b. 3/32" dia. @ 300 amps (+), 28 volts, 12 in./min with a 2 1/4" (extended) stickout.
  - c. 5/32" dia. @ 400 amps (+), 23 volts, 12 in./min with a 1 1/2" stickout.
  - d. 5/32" dia. @ 400 amps (+), 26 volts, 12 in./min with a 2 3/4" (extended) stickout.

On double "V" joints the low current procedure should be used on the first two automatic passes on each side.

5. Voltage variations do not affect the chemistry of the weld deposit; however, a voltage which is too high will give a concave shape which may crack. When the arc voltage is too high arc blow porosity may occur. The preferred bead shape is flat to slightly convex.

III. The recommended operating range for 3/32" diameter LAC electrodes is 250-500 amperes DC(+). The optimum setting for butt and heavy plate welding is 400 amps DC(+). The recommended operating range for 5/32" diameter LAC electrodes is 400-600 amperes DC(+). The optimum setting for butt and heavy plate welding with 5/32" diameter LAC electrodes is 500 amperes DC(+). Increasing the amperage beyond the recommended range will result in humped beads which do not wet properly and in a deterioration of the mechanical properties. This happens because the amount of metal is too great for the amount of flux melted. Amperage settings below the recommended operating range are unstable and result in excessive short circuiting of the welding arc.

IV. Standard electrical stickouts with LAC electrodes should only be used when required by equipment limitations. Whenever possible, however, the following additional advantages can be obtained with LAC through the use of extended stickout procedures:

1. Increased deposition rates. (See Figure 1.)
2. Improved HAZ properties. The HAZ impact properties deteriorate with increasing heat input. Deposition rates can be maintained at lower amperage settings with extended stickout procedures which will result in improved HAZ impact properties.
3. Improved crack resistance. Extended stickout combined with lower currents reduces the penetration and base plate admixture while maintaining high deposition rates. This is especially advantageous on crack sensitive steels where special precautions must be taken with any process to prevent both longitudinal and transverse cracking.
4. Increased resistance to arc blow porosity.

V. The proper voltage to current relationship for butt or heavy plate welding with single LAC-Ni2 and B2 electrodes is illustrated in Figure 4. For LAC-M2, add 2 volts to the voltage determined from Figure 4.

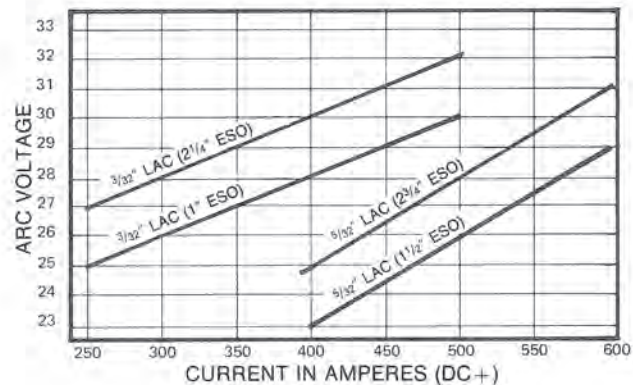

Figure 4

- VI. LAC electrodes Ni2 and B2 are designed to weld with either single or tandem arcs. LAC-M2 is designed for single arc only. Single arc welding should be at a travel speed between 10 to 25 inches per minute on butt welds. Welding at travel speeds in excess of 25 in./min may result in porosity and ropery weld beads due to an excessive quench rate. Travel speeds less than 10 in./min can result in an unstable arc and porosity due to puddle interference.
- VII. Run-off tabs should be sufficiently large to minimize the arc blow conditions which exist at or near the end of the weldment. This arc blow tendency increases with increasing weldment size and, if severe enough, can cause porosity, humped beads and cracking.

- VIII. All mill scale, rust and scale from flame cutting should be removed from the joint area prior to welding for optimum mechanical properties and good weld bead condition. The joint must also be free of moisture, and other contaminants such as cutting or machining oils.
- IX. For fillet welding procedures consult your Lincoln representative. Remember, for best results, mill

scale and other contaminants must be removed from the joint area. Optimum bead appearance is obtained on descaled plate.

- X. Excessive flux pile heights will result in humped, poorly wetted beads. This condition can become especially severe in the root of deep, narrow weld joints. The flux pile height should be the minimum height required to prevent flashthrough.

## LINCOLNWELD® FLUXES

Lincolnweld® 880, 882, 880M, MIL 800 and 980 flux have been formulated to produce exceptional mechanical properties. These special formulations, however, are less resistant to porosity due to contaminants such as moisture, rust, mill scale, oil, etc. than are general purpose welding fluxes. It is necessary, therefore, when welding with these fluxes to re-

move any such contamination from the weld joint. Under humid or extended storage conditions it is also recommended that these fluxes be heated to a minimum of 250°F prior to use. This precaution will minimize the possibility of porosity and will assure that optimum mechanical properties are achieved.

## STORING AND REDRYING SUBMERGED ARC WELDING FLUXES

Submerged arc welding fluxes and other low hydrogen welding products must be dry to perform properly.

Lincoln agglomerated fluxes in their original unopened bags will remain dry indefinitely in good storage conditions.

When the bags are opened or punctured, remove the flux and store it in closed containers in a dry area. Lincoln submerged arc fluxes *do not* pick up moisture. However, moisture contamination of exposed flux can occur by simple condensation of moisture from the surrounding air. This condensation of moisture also occurs on steel plate and everything else stored in the same location. Condensation is especially severe under humid conditions when the air temperature drops (usually after sundown).

When opened bags are exposed to air for a few days or when sealed bags are stored in unusually damp conditions, the flux may experience contamination by condensed moisture. Depending on the amount of moisture, weld quality can be reduced as follows:

1. Moisture reduces the ability of this low hydrogen welding process to resist underbead cracking on hardenable base steel.
2. Moisture may cause internal porosity. Detecting the porosity may require x-ray inspection or other non-destructive testing.
3. A relatively high moisture content causes visible external porosity in addition to internal porosity. It may also cause

**WARNING:** Using flux with improper moisture content may result in a reduction in weld quality. Many variables beyond the control of The Lincoln Electric Company affect the results obtained in the use of redried flux. These variables include, but are not limited to, redrying procedure, welding procedure, plate chemistry and temperature, weldment design, fabrication methods and service requirements. Therefore, the serviceability of redried flux and the product or structure on which it is used, is and must be the sole responsibility of the builder/user.

excessive slag fluidity, a rough weld surface and difficult slag removal.

4. Severe moisture contamination can cause weld cracks, underbead cracking, severe porosity, poor appearance and slag problems.

To redry flux, heat to a minimum temperature of 500°F and hold the mass long enough to raise the entire bulk of the flux to that temperature. Keep the entire mass at this temperature for a minimum of one hour. Severe moisture contamination may increase the time at temperature required for complete drying. Drying temperatures in excess of 900°F are not recommended for MIL 800 or 880M. Do not use drying temperatures above 450°F for 8500-H2, Mil800-H or Mil800-HPNi.

Do not attempt to redry flux in drums or any large containers where penetration of the heat throughout the entire mass is difficult.

### Customer Assistance Policy

The business of The Lincoln Electric Company is manufacturing and selling high quality welding equipment, consumables, and cutting equipment. Our challenge is to meet the needs of our customers and to exceed their expectations. On occasion, purchasers may ask Lincoln Electric for advice or information about their use of our products. We respond to our customers based on the best information in our possession at that time. Lincoln Electric is not in a position to warrant or guarantee such advice, and assumes no liability, with respect to such information or advice. We expressly disclaim any warranty of any kind, including any warranty of fitness for any customer's particular purpose, with respect to such information or advice. As a matter of practical consideration, we also cannot assume any responsibility for updating or correcting any such information or advice once it has been given, nor does the provision of information or advice create, expand or alter any warranty with respect to the sale of our products.

Lincoln Electric is a responsive manufacturer, but the selection and use of specific products sold by Lincoln Electric is solely within the control of, and remains the sole responsibility of the customer. Many variables beyond the control of Lincoln Electric affect the results obtained in applying these type of fabrication methods and service requirements.



C5.610 12/99

## THE LINCOLN ELECTRIC COMPANY

Local Sales and Service through Global Subsidiaries and Distributors

Cleveland, Ohio 44117-1199 U.S.A.

TEL: 216.481.8100 FAX: 216.486.1751 WEB: www.lincolnelectric.com





## MAKING SUBMERGED ARC WELDS IN THE FLAT AND HORIZONTAL POSITIONS



This bulletin covers joint design, backup bars, flux support, and other requirements for high quality submerged arc welding on flat plate particularly when using fully automatic welders. For similar information on roundabout applications request bulletin C5.630. Request bulletin C5.600 HOW TO MAKE SUBMERGED ARC WELDS for additional information about the effect of procedures and operating variables on weld quality.

### BUTT WELDS

Butt welds are made on a wide range of steel thicknesses ranging from 14 gauge sheet metal to plate several inches thick. For easy understanding, butt welds are broken into three categories – sheet metal, square edge, and deep groove butt welds.

#### SHEET METAL

Controlling distortion and preventing burn through are principal considerations in making submerged arc butt welds in sheet metal. To control distortion the work must be rigidly supported frequently by using a copper or steel back-up bar. The back-up bar is also important in preventing burn through.

When using a steel back-up strip a small gap is left between the plates. The weld penetrates into the steel strip so it becomes an integral part of the weldment.

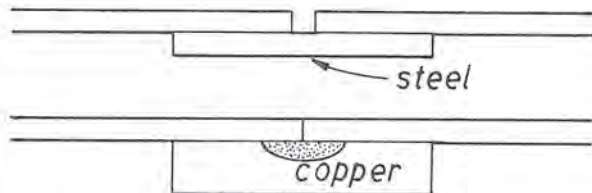

Figure 1

When the added steel strip is undesirable, a copper bar is used. The copper bar may be flat or it may have a small groove machined in it depending upon the desired shape of the backside of the bead. The groove should be wider than the back bead to prevent undercut at the bead edges. When required for extra smooth backbeads, the groove is large enough to accommodate flux poured into it before the parts are clamped in place.

#### SQUARE EDGE BUTTS

100% penetration for full weld strength without burn through is usually required in making square edge butt welds.

Plates up to 3/4" thick can be butted tight and then welded with one pass from each side. With normal sheared or flame cut edges 60% penetration is practical from the first side. If the edges are machined and fitted tightly together, penetration up to 80% is possible.

When the two edges are butted tightly together, particularly on 5/8" and 3/4" steel, the buildup bead on top of the joint becomes large with irregular edges. Excessive buildup or irregular beads can be reduced either by beveling the edges of the plates or by leaving a gap between the plates.

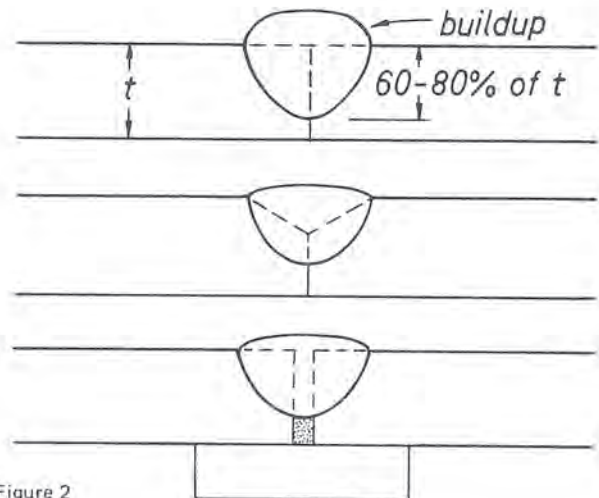

Figure 2

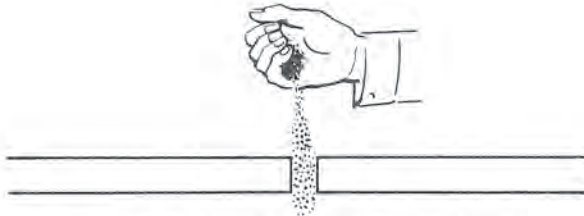

Figure 4 — If flux spills through the gap, support is needed.

Gaps of any kind increase penetration. As a rule of thumb, if the gap is large enough for loose flux to spill through, either a backup or a manual seal bead is required to support the flux.

Seal beads can be made either with manual low hydrogen electrode or semiautomatic equipment. For 1/2" or thicker steel put seal beads on the second pass side (Figure 5A). The seal beads should be on the first pass side on thinner material (Figure 5B).

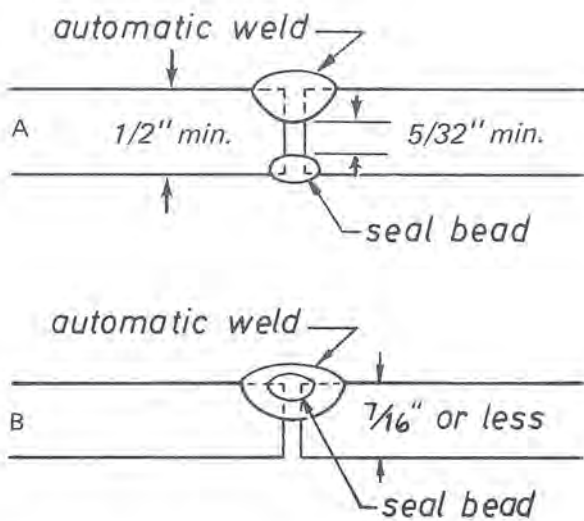

Figure 5 — Location of the seal beads depends on material thickness.

**CAUTION:** When there is a chance for flux to be trapped between the weld being made and the back of the joint, porosity could result. The porosity might be internal (root porosity) or surface porosity (large holes).

To eliminate this problem, penetration into the back-up bead or plate is necessary, or reduce penetration to allow at least a 5/32" space between the weld and the back-up (see Fig. 5A).

On Steel up to 1/2" thick full penetration welds can be made from one side using a gap and a steel or grooved copper back-up bar. The steel back-up bar remains as a permanent part of the weldment (Figure 6).

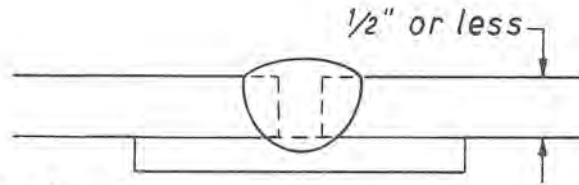

Figure 6

Always avoid making beads too deep and narrow (Figure 7A) or too wide and "hat shaped" (Figure 7B). These beads have a tendency for internal cracking.

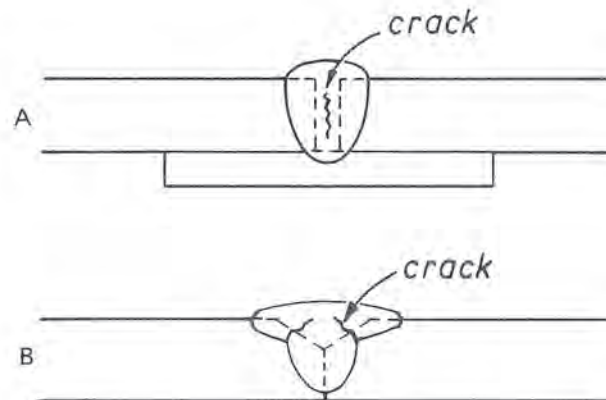

Figure 7 — 'A' tends to crack because it is deeper than it is wide. 'B' tends to crack because it is "hat shaped."

## DEEP GROOVE WELDS — Multiple Pass

The first pass in a deep groove weld requires the same considerations of penetration and burn through as a square edge butt weld. The only difference is that the root face, rather than the entire material thickness, is important.

Flux depth, plate levelness, and slag removal are all important in deep groove welding.

Because of the shape of a deep groove it is easy for the flux to pile up to a depth of more than 1". Excessive flux depth in a deep groove can cause poor bead shape similar to that caused by bad arc blow. Care must be taken not to use a greater flux depth than is necessary. Use only enough flux to prevent excessive flashing.

Multiple pass welds tend to have large molten pools which are quite fluid and will "run" if given the opportunity. Therefore, the work should be level or slightly up-hill as discussed in the section on "Welding on Inclined Plates" on page 7.

Slag removal can be a problem in deep groove welding. Small, slightly convex beads (Figure 9B) clean much more easily than large, concave beads (Figure 9A). When slag removal difficulties are encountered, **lower the voltage**. This

will produce the more convex bead required for improved slag removal. If further improvement is desired, increase the travel speed to produce a smaller weld bead.

These changes will also produce less crack sensitive bead shape which is always an important consideration in deep groove applications.

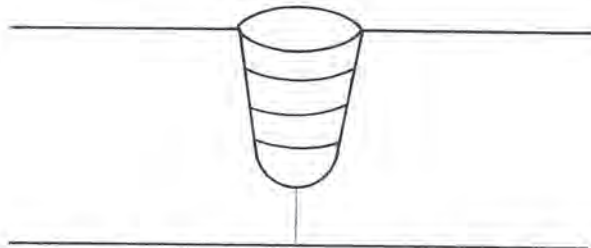

9A — Difficult to clean. Also wide beads made at high arc voltages pick up more manganese and silicon.

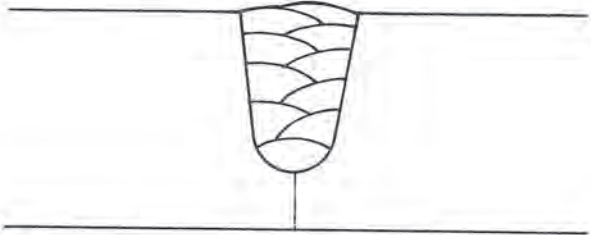

9B — Easy to clean.

Figure 9 — Small, well shaped beads that do not completely bridge across the groove are easier to clean than large concave beads.

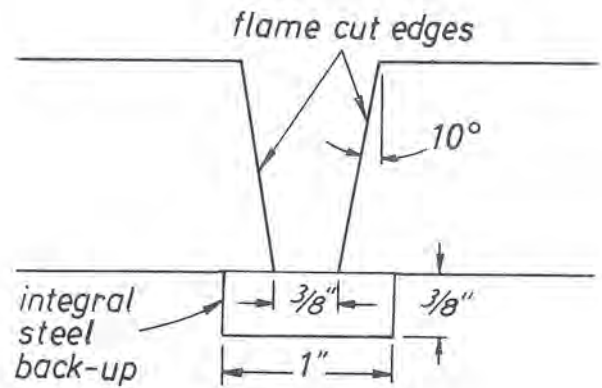

10A — Inexpensive Preparation

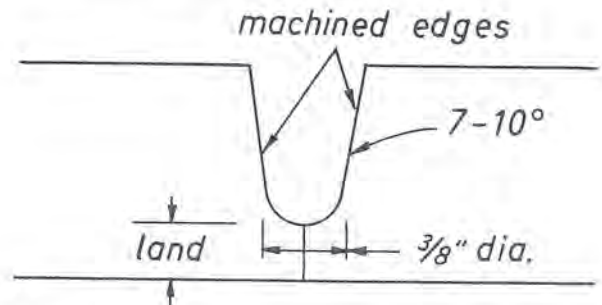

10B — Expensive Preparation

Figure 10 — The joint preparation shown in Figure 10A can be prepared at less cost than the one shown in Figure 10B. Since welding time and quality is about equal for both joints, the one shown in Figure 10A should be considered when practical.

## FILLET WELDS

The principle considerations in making fillet welds include equipment, bead shape, penetration, arc blow, and the fact that fillets are restrained joints.

### EQUIPMENT

When welding with fully automatic equipment, use of the fillet-lap attachment with Lincoln heads is recommended for making horizontal fillet welds. This attachment leaves the head in a vertical position and turns the electrode to the proper angle for making the weld. The standard straight contact assembly should be used for flat or trough position fillet welds. For any application the flux hopper should not be tilted more than 40 degrees from the vertical. A greater tilt results in irregular flux flow.

### BEAD SHAPE

A  $5/16$ " leg size is the maximum single pass fillet weld that normally can be made with one electrode in the hori-

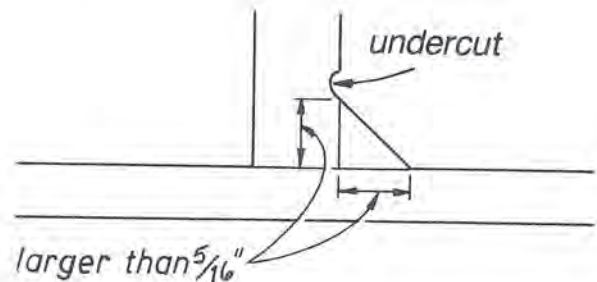

Figure 11

zontal position. Attempting to make larger beads may result in undercut as shown in Figure 11. Horizontal fillet welds up to  $1/2$ " leg size can be made in one pass using tandem arc procedures. Single pass flat position fillet welds as large as  $3/4$ " are practical.

See Figures 12 through 16 for additional considerations in making fillet welds.

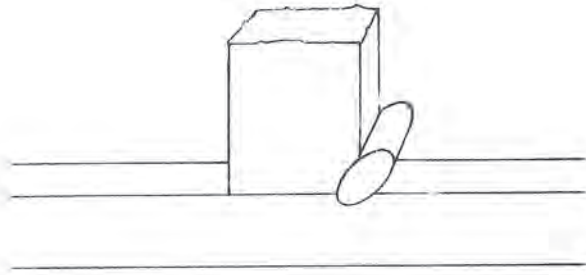

Figure 12 — Beads like this result from excessively fast travel speed, deep flux pile, high current, low voltage, or an uphill position.

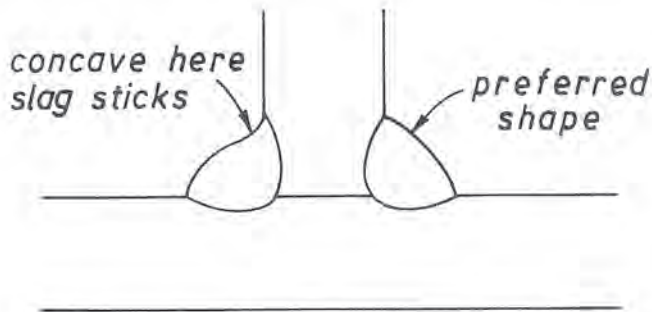

Figure 12A — If fillet welds assume a concave shape at the top edge making slag removal difficult, decrease voltage just enough to make the bead shape slightly convex.

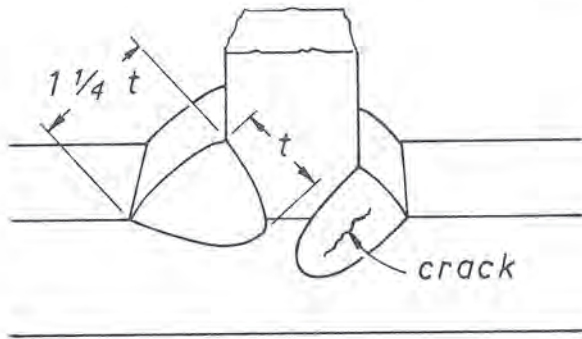

Figure 13 — Welds that are slightly wider than they are deep are best. Deep, narrow beads are prone to internal cracking.

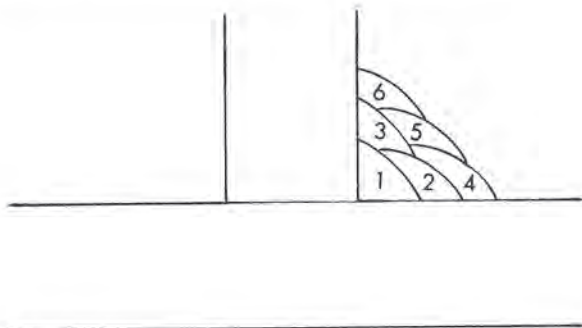
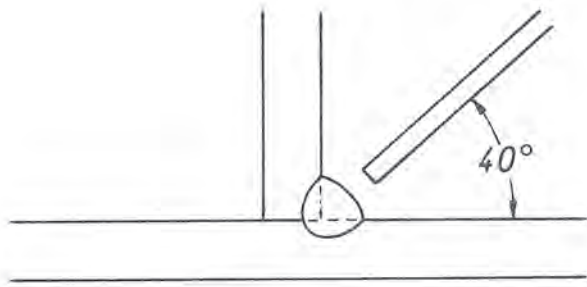
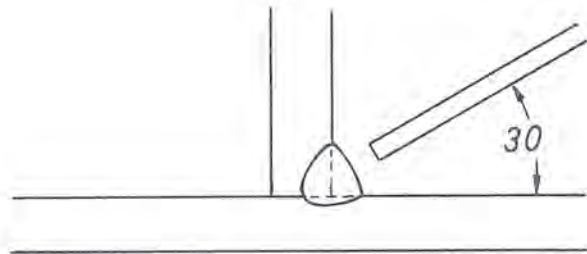

Figure 14 — Proper bead sequence for multiple pass fillets.



15A — Equal Legs



15B — Deep Penetration

Figure 15 — Positions of electrode for equal legs and for maximum penetration in horizontal fillet welds.

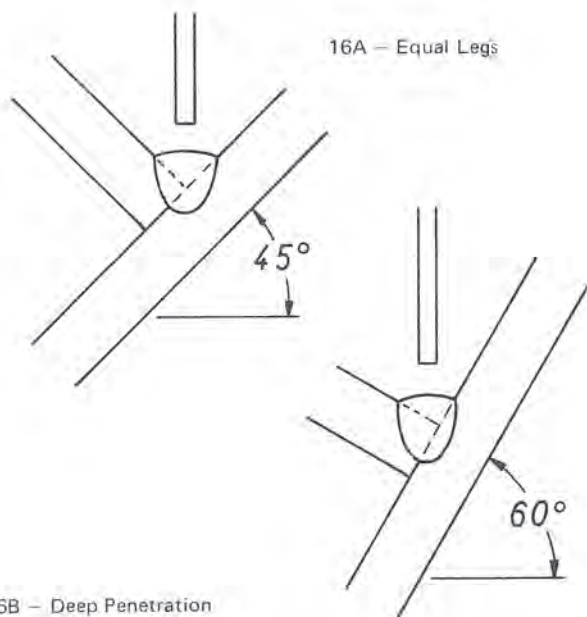

16B — Deep Penetration

Figure 16 — Positions of electrode for equal legs and for maximum penetration but unequal legs, in flat fillet welds.

## ARC BLOW

Arc blow can cause porosity. DC(-) polarity and small electrodes are particularly susceptible. It most frequently occurs on automatic high-speed welds on thin steel but can occur on heavier plate mostly on complex joints. Back blow porosity sometimes appears in multiple pass semiautomatic welding applications when using a drag technique. The best way to eliminate the porosity is to eliminate the arc blow. See bulletin S620 for possible methods.

## RESTRAINED JOINT

As a fillet shrinks during cooling, it tends to pull the two plates together. When the plates are rigidly fixed the metal cannot shrink during cooling so it must stretch. This causes a natural tendency for cracking in fillet welds. The best method to overcome this cracking tendency is to leave a 1/16" gap in the joint as shown in Figure 17.

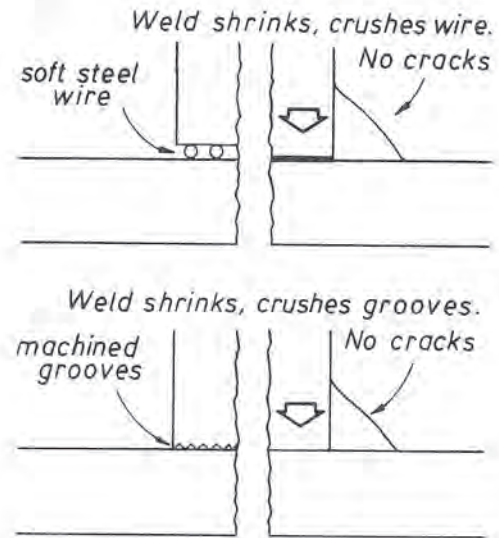

Figure 17

## LAP WELDS

Tight fit-up and electrode alignment are two principal considerations in making lap welds.

The two plates must be tightly held together because gaps invariably result in poor bead shape and unsound welds. The tight fit makes lap welds particularly susceptible to porosity so the presence of moisture, paint and other contaminants must be controlled.

Position of the electrode is critical to lap weld quality. If the electrode is too high up the top plate, the weld may not

properly fuse to the bottom plate. If it is too far away from the top plate, the weld may not properly fuse to the top plate and may burn through the bottom plate.

With fully automatic equipment, use the fillet-lap attachment for 3/16 - 3/8" thick steel in the horizontal position. Use the standard straight contact assembly for thinner steel. Lap welds on 3/8" or thicker material become fillets.

Through-laps can be made on 10 gauge and thinner material when appearance is not important. When there is a difference in thickness of the two plates, welding the thin plate to the thick plate is recommended as illustrated in Figure 19.

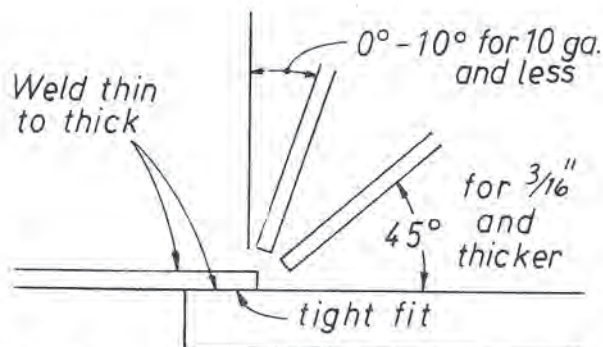

Figure 18

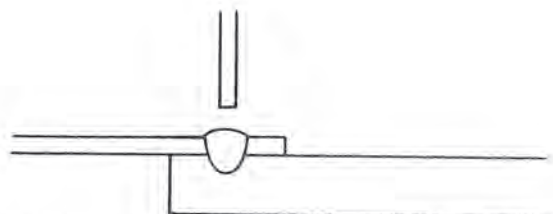

Figure 19

## PLUG WELDS

The principal consideration in making plug welds is to be sure that the weld fuses to both plates and completely fills the hole. A 3/4" diameter is normally the maximum size used for plug welding. Larger plugs are sometimes made using the semiautomatic welder and circulating the arc around the plug to completely fill the hole. Plugs up to 2" in diameter and 2" deep are made in this manner.

Since the plug is always completely covered with the flux, it is difficult to tell when the plug is filled, therefore, plug welds are usually timed.

Frequently, to reduce the size of the crater at the top of the plug the current is reduced for the last few seconds before the arc is broken.

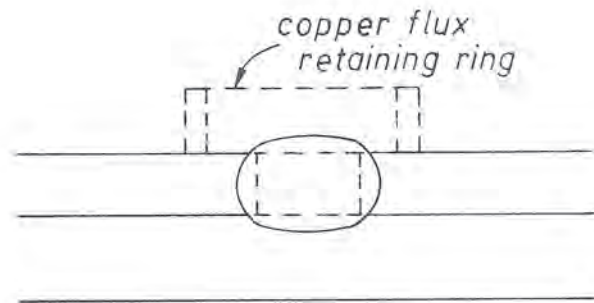

Figure 20 — Plug welds must fuse into both plates and fill the hole.

## EDGE WELDS

Edge welds are made at high travel speeds on sheet metal from 10 gauge to about 18 gauge. The major problems are guiding the electrode and supporting the flux.

The electrode must be accurately guided so it is always positioned directly over the joint. Support is necessary to keep the flux from spilling over the edge and because the supported flux in turn holds the molten metal while it freezes. For best results weld about 10 degrees downhill.

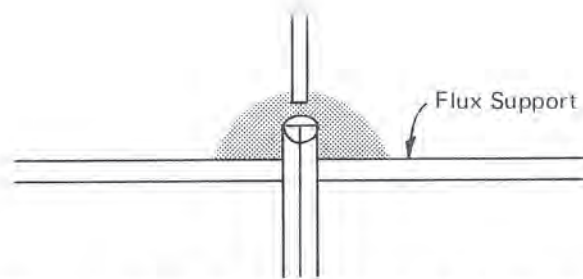

Figure 21 — Position the flux supports as near to the weld as practical.

## WELDING ON INCLINED PLATES

Normally, the work should be positioned level because welding on an inclined plate may distort bead shape and affect penetration. Welding uphill increases penetration and welding downhill reduces it. But there are two situations where inclining the work is advantageous.

Since excessive penetration is undesirable when welding sheet metal, a 10 to 20 degree downhill angle reduces penetration permitting the use of higher currents and faster

welding speeds. Inclines of more than 20 degrees result in distorted beads.

On heavy deep groove joints, particularly when made with multiple arcs, there is a large molten pool which is fluid. If the work is slightly downhill, this large pool will roll ahead of the arc as shown in Figure 22 and produce poor welds. On this type joint running the bead slightly (about 2°) uphill eliminates this problem.

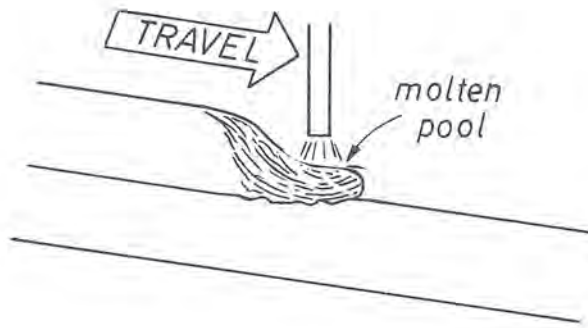

Figure 22 — When the molten pool runs ahead of the arc, the arc acts on the pool instead of base metal and normal crater. As a result:

1. Arc is unstable
2. Bead is wavy
3. Weld lacks penetration

## RUN-OFF TABS AND SPACERS

On joints where the weld must run to the end of the plates, some means of restraining the metal so it doesn't spill off the end must be provided. Run-off tabs are the most commonly used method. Then the arc is started on one run-off tab tacked to the start end of the weld and is stopped on a second tab at the end of the weld. The tabs are large enough so the entire bead on the work itself is properly shaped. Run-off tabs must be wide enough to support the flux and be sealed at the bottom to prevent burn through. Run-off tabs should conform to groove joint configuration (Figure 23). They are removed after the weld is complete.

A variation of the run-off tab is a copper dam which holds the flux which, in turn, supports the weld metal.

When several parts are placed side by side, copper blocks placed between the plates allow the arc to be maintained for continuous welding.

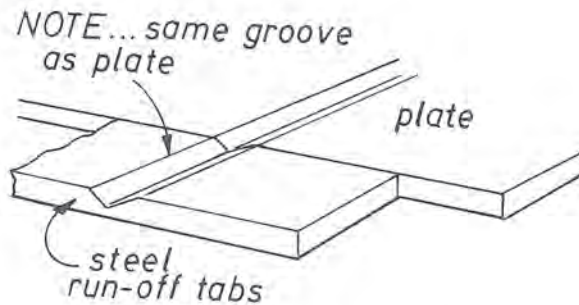

Figure 23 — The most effective run-off tabs conform closely to the shape and contour of the joint.

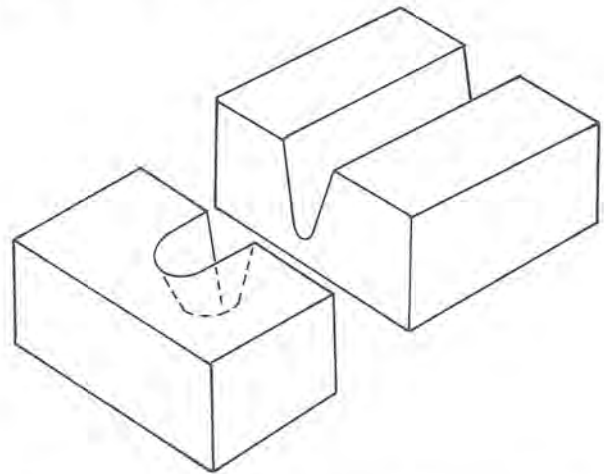

Figure 24 — Copper dams are sometimes used instead of run-off tabs.

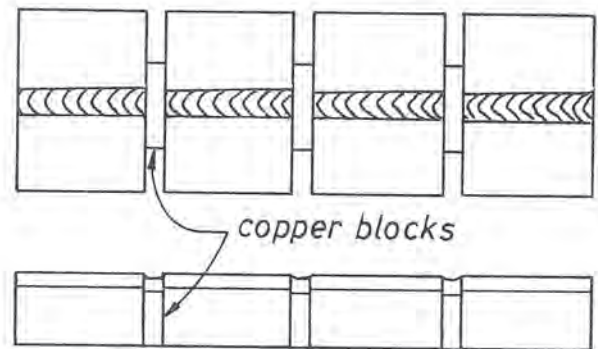

Figure 25 — Copper blocks make good dividers when several parts are welded without breaking the arc. They should be kept low enough so arc does not touch them.



Customer Assistance Policy

The business of The Lincoln Electric Company is manufacturing and selling high quality welding equipment, consumables, and cutting equipment. Our challenge is to meet the needs of our customers and to exceed their expectations. On occasion, purchasers may ask Lincoln Electric for advice or information about their use of our products. We respond to our customers based on the best information in our possession at that time. Lincoln Electric is not in a position to warrant or guarantee such advice, and assumes no liability, with respect to such information or advice. We expressly disclaim any warranty of any kind, including any warranty of fitness for any customer's particular purpose, with respect to such information or advice. As a matter of practical consideration, we also cannot assume any responsibility for updating or correcting any such information or advice once it has been given, nor does the provision of information or advice create, expand or alter any warranty with respect to the sale of our products.

Lincoln Electric is a responsive manufacturer, but the selection and use of specific products sold by Lincoln Electric is solely within the control of, and remains the sole responsibility of the customer. Many variables beyond the control of Lincoln Electric affect the results obtained in applying these type of fabrication methods and service requirements.



**THE  
LINCOLN ELECTRIC  
COMPANY**

**Local Sales and Service through Global  
Subsidiaries and Distributors**

Cleveland, Ohio 44117-1199 U.S.A

TEL: 216.481.8100

FAX: 216.486.1751

WEB SITE: [www.lincolnelectric.com](http://www.lincolnelectric.com)

**Submerged Arc  
C5.620 12/99**

*DISTRIBUTED BY:*

# How To Make CIRCUMFERENTIAL WELDS In Submerged Arc Welding



Circumferential, or roundabout, welds differ from those made in the flat position in two important considerations.

*First* is the tendency for molten flux and weld metal to spill off the work. This tendency is overcome by:

1. Adjusting the wire position.
2. Limiting bead size through lower current, lower voltage and/or faster travel speeds than normal.
3. Supporting the loose flux.

*Second* is the increased importance of slag removal. If a multiple pass weld is being made, the slag must be removed as welding progresses. This is principally overcome by controlling joint design, bead size and shape.

## OVERCOMING SPILLAGE

On roundabout welds the pool of molten weld metal and slag tends to sag or spill. In severe cases, the metal actually spills off the work. In less severe cases, the molten pool starts to run, but freezes before it spills. This results in a distorted bead shape as shown in Figures 1B and 1C.

### Effect of Wire Position

To prevent spillage or distortion of the bead shape, welds must solidify as they pass over the vertical center of the part. This means that the wire must be positioned ahead of vertical center. Figure 1 illustrates bead shapes that result

from various wire positions. Note also that the bead in Figure 1B has more penetration and a greater tendency for burnthrough than the bead in Figure 1A. The opposite is true of Figure 1C.

Suggested off center distances for positioning wires are given in Figure 2 on the following page.

The wire must point nearly perpendicular to the surface of the work, particularly on small diameter work. Positioning it at an angle of incidence can result in a distorted bead shape and poor arc striking.

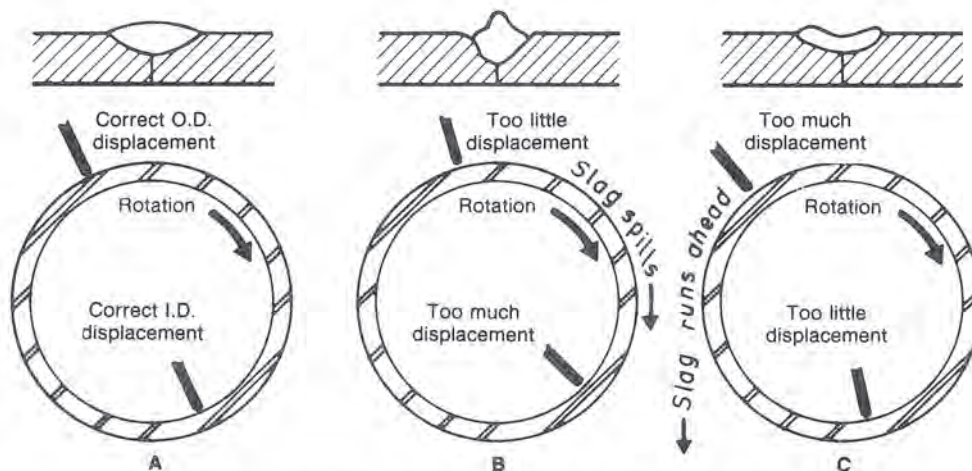

Figure 1 — Effect of off-center displacement on bead shape.

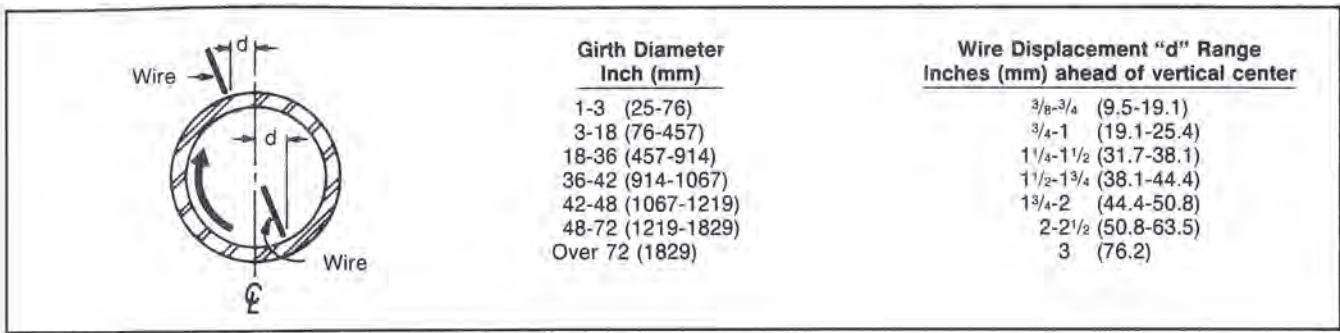

Figure 2 — Approximate off-center distance of wire positioned for various diameters of work. Actual displacement may be outside of these ranges for a particular application.

### Effect of Current and Travel Speed

Regardless of wire position, if the molten pool is too big for the diameter of work, the metal will spill simply because it can't freeze fast enough. Bead size depends on the amperage and travel speed used. Reduced current and/or increased travel speed reduces the size of the bead. Lower voltage reduces slag volume.

Obviously, on small diameters a small bead must be used. Figure 3 gives an indication of the maximum size single pass weld that can be made on small diameters. Generally it is better to set up small diameter work for 3 o'clock welding, if possible. For larger diameters, Figure 4 gives procedures that produce good welds with minimum difficulty.

### Flux Support

The flux itself, being granular, will spill off small diameter work if not controlled. This leaves the arc uncovered and results in poor quality bead. One method of overcoming this is to use a nozzle assembly which pours the flux right over the arc and gives it less chance to spill. A wire brush or other flexible heat resisting material should be attached to the nozzle so it rides the work ahead of the arc, as shown in Figure 5, will also support the flux and prevent spilling. The support must be electrically insulated from the electrode.

Flux support is also necessary at the edges of the work. Sheet metal rings tack welded to the edge or flexible retainers that ride the edge, as shown in Figure 6, effectively support the flux so beads can be made right on the edge of the work.

One precaution in this matter — too much flux encourages sagging or spillage. The amount of flux should be just enough to adequately cover the arc, so that the light of the arc reflects on the electrode.

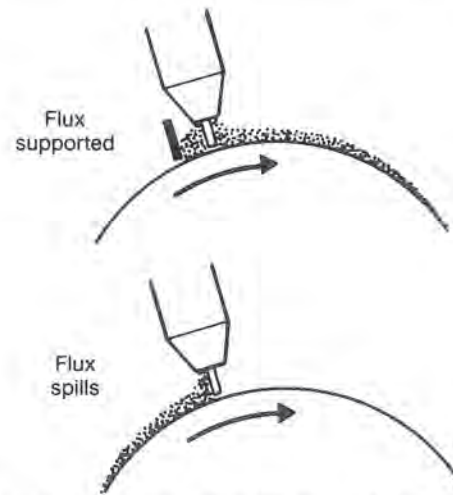

Figure 5 — Flux supports which ride the work ahead of the arc prevent flux spilling.

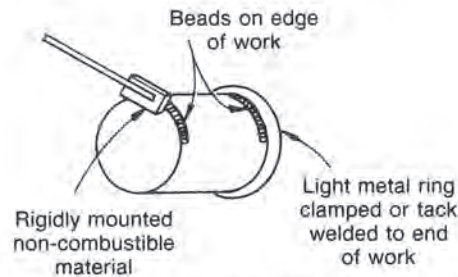

Figure 6 — Edges require flux supports to permit welding close to the edge.



Figure 3 — Approximate size of the largest bead attainable on small diameters. To obtain these welds, backups are required on thin sections and special arrangements to prevent flux spilling may be necessary.

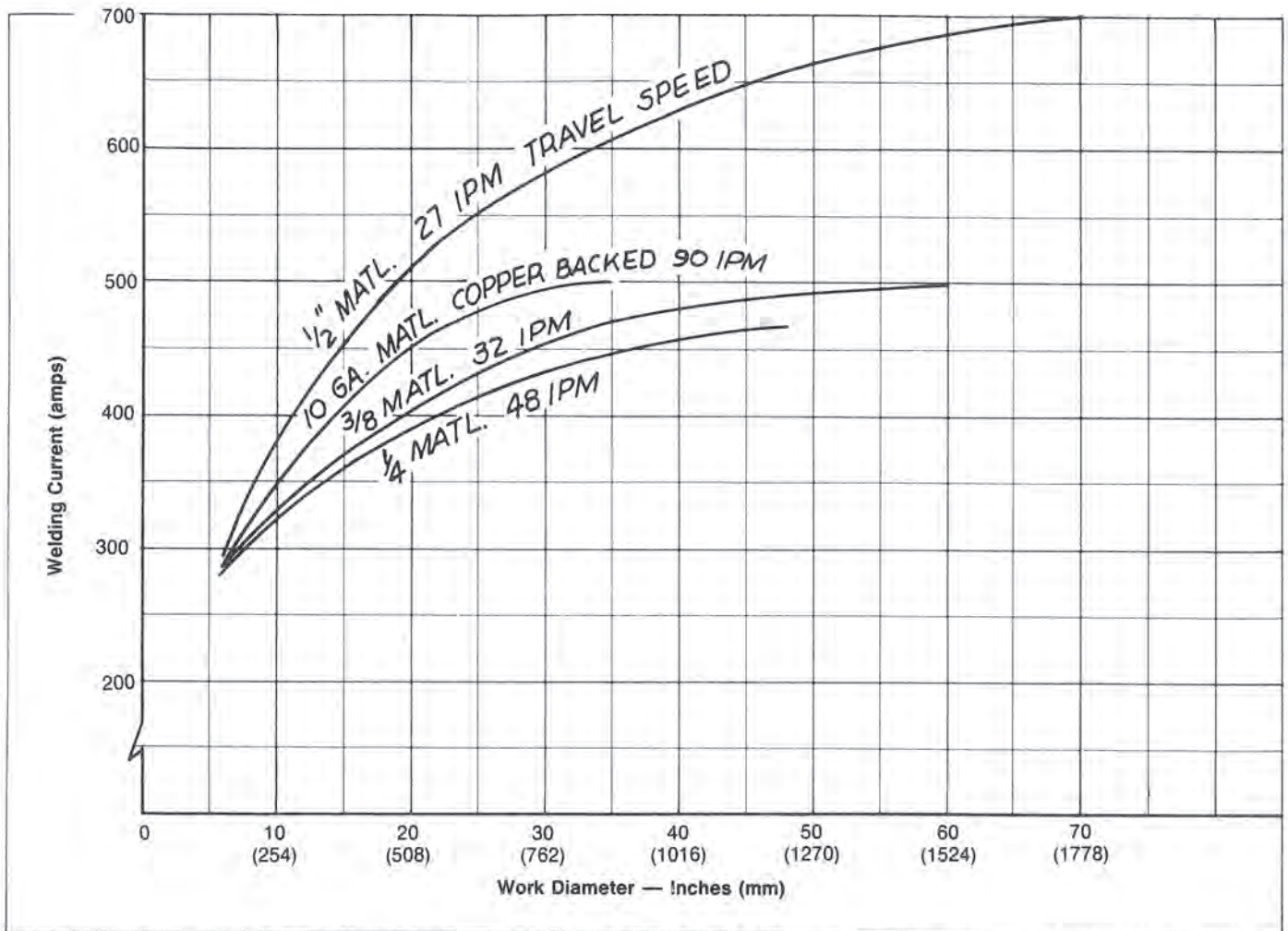

Figure 4 — Approximate maximum current (at the speeds given) for different thicknesses of various diameters work without special setup to control spilling. Beyond upper limit of curves use standard horizontal procedures.

## Slag Removal

On the first pass of *two pass welds*, a bead which washes up to the top edges of the joint is much easier to clean than a bead which does not quite come up to the top edge. See Figure 7.



Figure 7 — The first pass of a *two pass weld* should wash up to the edges for best slag removal.

On *multiple pass welds*, slag removal is important because, if the weld is to run continuously, slag must be removed before it makes a complete revolution. Two factors are particularly important in improving slag removal. They are bead size and bead shape:

1. Smaller beads tend to cool more quickly, which reduces slag sticking.
2. Flat to slightly convex beads (Figure 8) make slag removal much easier than undercut beads which tend to lock the slag to the weld at the edges of the bead.

This improvement in bead shape and slag removal is readily accomplished by *lowering the arc voltage*.

In heavy work, it is usually faster to put in many small beads with a continuous operation than to put in larger beads and have to stop to remove slag. See Figure 8. The amount of current used on the job determines the wire melt-off rate and, consequently, how fast the joint is filled. It makes no difference whether the travel speed is slow and the beads are large, or the travel speed is fast and beads are small as far as deposit rate is concerned.

What is important is the fact that faster speeds make smaller beads from which the slag will peel off easily. Frequently, this means the difference between continuous operation and

periodic stopping to remove slag. Any stopping is lost labor and overhead expense. Easy cleaning and smooth, good-looking welds reduce cost and build operator prestige and morale. Incidentally, multiple passes improve weld quality, especially notch toughness.

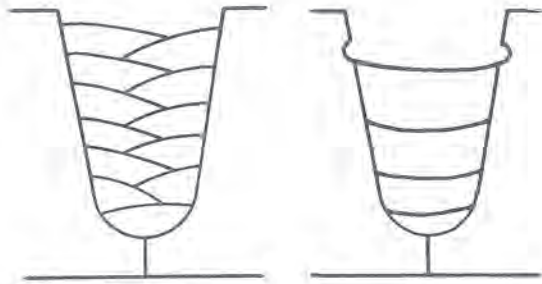

Figure 8 — Using small, well shaped beads (left) improves slag removal. Small beads can be made with faster travel speeds and no decrease in current or deposition. Beads like those on the right cause the slag to lock-in and remove only with difficulty.

Another way to improve slag removal, particularly on small diameter work that gets very hot during welding, is to put an air jet on the weld. Positioning the air nozzle so it blows on the weld at about the 2:30 o'clock position is usually best. The air cools both the work and the slag so that it has less tendency to stick. See Figure 9.

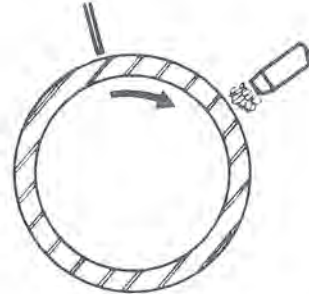

Figure 9 — Air applied to the work at the 2:30 o'clock position will cool both the work and the slag and aid slag removal.

## FLUX COLLECTION

As circumferential welds frequently involve long continuous welds, a comment on flux collection is timely. Keeping the flux clean has several advantages. It produces sound, smooth welds and will not clog the flux feeding mecha-

nism. Try to catch the flux before it reaches the floor. Use a vacuum recovery unit to remove dust and a magnetic separator to take out magnetic particles, when necessary.

## GROUNDING

It is not sufficient to simply clamp a ground lead to some stationary part of the fixture as this will cause welding current to pass through the bearings of the rotating part of the fixture. This will cause arcing of the bearings and eventually destruction of the bearings. Grounding may be done

through one or more sliding shoes of copper or copper-graphite which contact a clean surface on the rotating fixture, thereby preventing current from passing through the bearings. Alternately, special rotary grounds are available which permit efficient grounding of the rotating device.

## SUMMARY

Properly set up, roundabout welds are almost as easy to make as welds in the flat position. However, in setting up a circumferential job, check the following:

1. Bead size as determined by the welding current and travel speed.
2. The electrode position and angle.
3. Flux support for small diameter work.
4. Flux support for edges.
5. Slag removal.
6. Clean flux recovery system.
7. Grounding.



**THE  
LINCOLN ELECTRIC  
COMPANY**

Local Sales and Service through Global  
Subsidiaries and Distributors

Cleveland, Ohio 44117-1199 U.S.A

TEL: 216.481.8100

FAX: 216.486.1751

WEB SITE: [www.lincolnelectric.com](http://www.lincolnelectric.com)

**Submerged Arc  
C5.630 12/99**

### Customer Assistance Policy

The business of The Lincoln Electric Company is manufacturing and selling high quality welding equipment, consumables, and cutting equipment. Our challenge is to meet the needs of our customers and to exceed their expectations. On occasion, purchasers may ask Lincoln Electric for advice or information about their use of our products. We respond to our customers based on the best information in our possession at that time. Lincoln Electric is not in a position to warrant or guarantee such advice, and assumes no liability, with respect to such information or advice. We expressly disclaim any warranty of any kind, including any warranty of fitness for any customer's particular purpose, with respect to such information or advice. As a matter of practical consideration, we also cannot assume any responsibility for updating or correcting any such information or advice once it has been given, nor does the provision of information or advice create, expand or alter any warranty with respect to the sale of our products.

Lincoln Electric is a responsive manufacturer, but the selection and use of specific products sold by Lincoln Electric is solely within the control of, and remains the sole responsibility of the customer. Many variables beyond the control of Lincoln Electric affect the results obtained in applying these types of fabrication methods and service requirements.

## Its Causes and Cures in Submerged Arc Welding



The use of submerged arc welding on work ranging from light gauge tanks to heavy machinery and huge structures attests the reliability and economic feasibility of the process. Nonetheless, occasional difficulties arise, particularly when setting up a new job. Frequently, these difficulties take the form of porosity in the weld. The following are a few hints that will help overcome this problem.

### POOR GRADE STEEL

The analysis of the steel, in general, has little effect on porosity of the weld metal, though very high or very low carbon content tends to increase porosity. The effect of low carbon content can be nullified by the use of a silicon-killed electrode such as L-61.

The principal exception to the above is the sulfur content found principally in such steels as the "free machining" grades. Sulfur tends to produce gases that must escape while the weld metal is still molten or be trapped in the weld metal and cause porosity.

Sulfur may cause trouble even when it is well within the preferred analysis range. This happens when it occurs as segregations. Sulfur segregations in steel have a much higher sulfur content than the analysis of the steel would indicate. Segregations may be detected with a deep etch of the cross section of the steel or by other chemical processes. Severe segregations may actually appear as laminations and cause large holes in the weld.

Where it is necessary to weld steels with sulfur segregations, use procedures that give minimum admixture (low current, negative polarity, large electrode size) and travel as slowly as possible to allow gases time to escape through the molten pool. On joints that are normally square edge butts, scarf the joint, and on joints that are normally beveled, increase the angle of the scarf. Use multiple pass procedures.



FIGURE 1 — Sulfur segregations — Dark lines in etched section above indicate areas of high sulfur concentration.

### CONTAMINANTS IN THE JOINT

The most frequent reason for porosity is the presence of rust, dirt, oil, paint, or other gas producing contaminants in the joint. Zinc based or epoxy based primers are especially difficult to weld over and may produce severe porosity due to the large volume of gases generated from these materials during welding. Weld joints must be clean of all foreign matter if satisfactory welds are to be obtained. The abutting edges themselves must be clean; cleaning the surface of the joint helps only slightly. (See Figure 2.)

Sodium nitrite solutions are sometimes used as rust preventative wash coats. The residue is clear and the plate appears clean and uncoated. This material will result in gassing and possibly porosity.

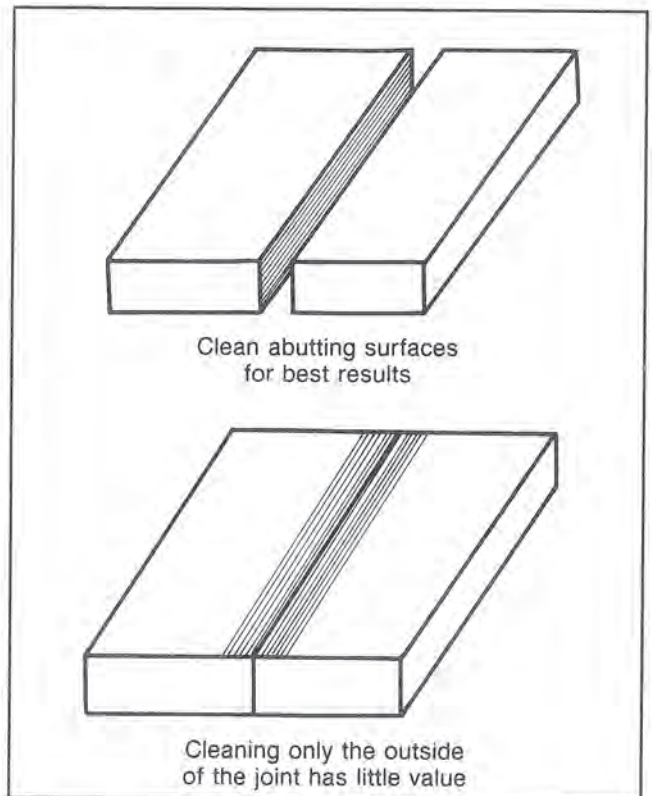

FIGURE 2 — Proper edge cleaning is essential to good submerged arc welding.

This is particularly true where mating (or faying) surfaces are involved. Virtually any rust preventative could result in porosity problems.

It is not necessary, however, to clean every edge that is to be welded with submerged arc. Edges that have been prepared by machining or flame-cutting can be satisfactorily welded without further cleaning if they are not rusty or oil-coated. Unprepared edges with normal "mill scale" can also be welded without further cleaning if the scale is not loose and flaky. Actually, even heavy mill scale can be welded satisfactorily if a silicon killed electrode, such as L-61, is used. However, welding speed may have to be decreased.

Note, however, that there are two types of "mill scale." The first is dark or black in color. It can cause surface pock marking. The second type is "red mill scale" which is reddish brown in color. It contains moisture and has the same detrimental effect as rust.

Power wire brushing cleans rust and "red mill scale" from the edges. Torch heating eliminates moisture in the rust. Although either will substantially reduce the porosity, they can both be used together for best results. Wire brush joints before they are fitted together. Then put a flame torch on the joint, about 1-2 ft (.30-.60 m) in front of the arc while welding, to drive off residual moisture. Be sure the torch is hot enough to heat the plate to 300-500°F (149-260°C). Insufficient heat may leave some moisture that will cause subsurface porosity.

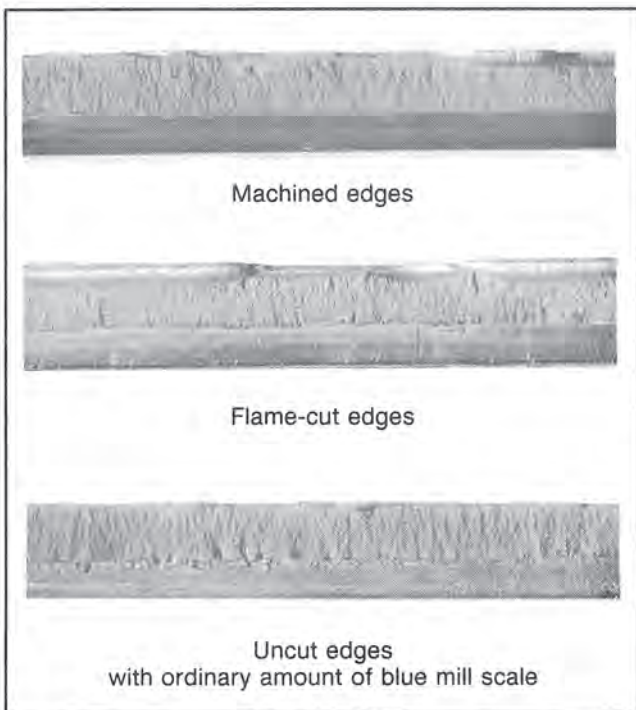

FIGURE 3 — Good, porosity-free welds can be made on machined and flame-cut edges and on uncut edges that have an ordinary amount of mill scale.

Oil, grease, die lubricants and other similar contaminants are frequently removed by degreasing and washing opera-

tions. When this is done, be sure that the washing compound is rinsed off completely and the work is completely dry before starting to weld. Low silicon L-60 electrode is best to resist porosity from organic contaminants.

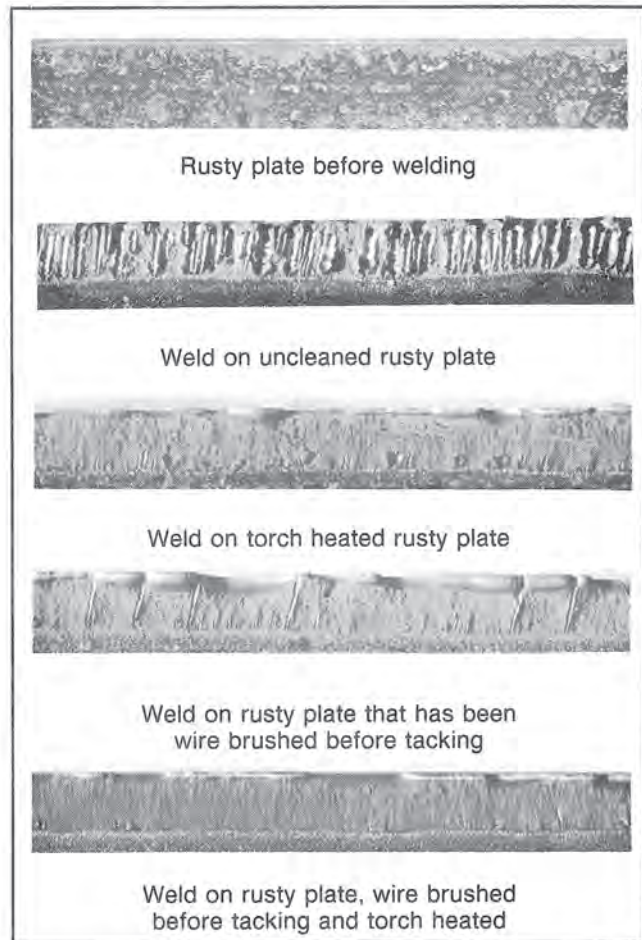

FIGURE 4 — Power brushing and torch heating will clean even the rustiest plate so that it is possible to make good, porosity-free welds.



FIGURE 5 — Porosity caused by oily plate.

### CONTAMINANTS IN THE FLUX

Any material which produces porosity when in the joint will also produce porosity when in the flux. The most common contaminants in flux are moisture, dirt and "mill scale."

Care must be taken to properly store flux whether the container has been opened or not. Welding flux may pick up moisture. Flux that is used repeatedly can also pick up moisture. For information on proper methods for redrying flux see Bulletin C5.660.



FIGURE 6 — Dirty flux can cause severe porosity.

Keep dirt out of the flux. This is not always possible, however, and the next best solution is the use of flux recovery equipment that removes the dirt and dust. Clean the dust bag of the recovery unit regularly or slugs of dust may fall into the recovered flux and result in severe holes similar to that shown in Figure 6.

On some joints, such as those inside tanks, excessive mill scale will fall onto the joint and contaminate the weld. Some of this scale may also be picked up by flux recovery equipment and contaminate the flux. Removing mill scale from flux requires a magnetic separator, such as the Lincoln K58.

Other contaminants may also be picked up with the flux by the recovery system. If they can't be eliminated by drying, by removal in the recovery equipment, or by a magnetic separator, it is best to discard the flux rather than risk porosity in welds.

### ELECTRODE CONTAMINATION

Under unusual storage conditions, electrode may become rusty. Rust may cause porosity, particularly in high speed welds on light gauge sheet metal. Added disadvantages of rusty electrode are excessive wear and arcing at the contact nozzle and improper feeding through the cables of semiautomatic welders. Rusty electrode should not be used.

Electrode that has become contaminated with oil, grease, dirt and the like should be cleaned before using. Occasionally a small amount of oil is put on the electrode in semiautomatic welding to facilitate feeding through the cable. If too much is added, it will cause porosity.

### INSUFFICIENT FLUX

There must always be a sufficient amount of flux over the arc to protect the molten metal from the air. By contrast, too much flux will result in poor bead shape.



FIGURE 7 — Gas pockets in the weld results from insufficient flux coverage.

The correct amount of flux coverage is indicated when the light of the arc reflects on the electrode. When less flux is used, the arc starts to flash through and scattered surface porosity may result. Insufficient flux coverage is more apt to occur on circumferential welds than on flat welds. Frequently,

on small circumferential welds, it is necessary to provide some mechanical means to support the flux around the arc. Similarly, if the slag spills off the weld before it has solidified, the weld may show surface porosity. Corner welds and multiple pass horizontal fillets are especially susceptible to this problem.

### TACK WELDS

Stick electrodes of the E6010, E6011, E7016 or E7018 classes should be used for tack welding when the tacks are to be covered with a submerged arc bead. These electrodes have good penetration and produce porosity free deposits. Slag removal is easy and, should some little slag be left or trapped, it will not produce porosity in the submerged arc bead. The slag from other types of electrodes may produce porosity.

### ARC BLOW

Arc blow can cause porosity. DC(-) polarity and small electrodes are particularly susceptible. It most frequently occurs on automatic high-speed welds on thin steel but can occur on heavier plate mostly on complex joints. Back blow porosity sometimes appears in multiple pass semiautomatic welding applications when using a drag technique.



FIGURE 8 — Porosity from backward arc blow is more common on the finish end of welds in light gauge sheet metal than in any other type of weld.

On light steel, the porosity from arc blow usually occurs in the last few inches of the weld. It always gets worse as the arc approaches the end of the seam. The best way to eliminate the porosity is to eliminate the arc blow. Some possible steps are as follows:

1. Weld away from the work connection.
2. Put a heavy tack weld at the finish end of the joint.
3. Clamp the work lead firmly to the work at the start end then weld toward the closed end of the fixture.

In building fixtures for light plate welding, use heavy copper or other non-magnetic material or keep all fixture steel at least 1" (25 mm) away from the arc and the steel being welded. If these solutions fail, use low silicon electrodes (L60), low voltage, reduced current and travel speed, and DC(+) polarity.

When surface porosity occurs in multiple pass semiautomatic welding, in addition to using low silicon (L-60) electrode, DC(+) polarity, and welding away from the work lead connection with reduced voltage, try the following:

1. Avoid tilting the electrode so it points back toward the finished weld because this increases the "back blow." Keep the electrode as close to vertical as possible.



- If the plate is less than 1" (25 mm) thick, use the flux with the best resistance to back low porosity (see bulletin C5.10).
- Increase the flux cone opening size for greater flux coverage.
- Avoid placing beads in locations which allow the molten flux to run off. A thick layer of molten flux must cover the puddle at all times.

## TRAPPED FLUX

Wherever there is an opportunity for flux to become trapped between the bottom of the bead being deposited and the other side of the joint, there is a possibility of porosity. This porosity may be either subsurface in the root of the weld or may come through to the surface as large holes.

The solution is either to leave at least  $\frac{5}{32}$ " (4.0 mm) between the root of the weld and the other side or to penetrate completely into the other side so that no unwelded space exists.

The most common example of applications where this is encountered is butt welds. The joint may be backed up by a manual weld, a back up strip, or even another automatic weld. If the gap between the plate edges is  $\frac{1}{32}$ " (.8 mm) or more, flux will spill into it ahead of the arc. Sound welds are obtained by having enough penetration so that the bead penetrates the back-up or by keeping penetration down so that the bead misses the back-up by at least  $\frac{5}{32}$ " (4.0 mm)



FIGURE 9 — This butt joint had a manual weld on the back side. Penetration came to within  $\frac{5}{32}$ " (4.0 mm) of the back-up bead and porosity resulted.



FIGURE 10 — This butt joint was identical to that in Figure 9 except that penetration missed the back-up bead by  $\frac{3}{16}$ " (4.7 mm). The weld was sound with no porosity.

**LINCOLN<sup>®</sup>**  
**ELECTRIC**

**THE  
LINCOLN ELECTRIC  
COMPANY**

Local Sales and Service through Global  
Subsidiaries and Distributors  
Cleveland, Ohio 44117-1199 U.S.A.  
TEL: 216.481.8100  
FAX: 216.486.1751  
WEB SITE: www.lincolnelectric.com

Submerged Arc  
C5.650 1/98



FIGURE 11 — Offset-lap welds inherently tend to trap flux in the bottom of the joint. First pass may be porous; second pass is sound.

Another application where this is sometimes a problem is offset-lap welds. It is necessary to penetrate past the corner to have porosity-free welds. Frequently it is difficult to get penetration to meet this requirement. Instead, two passes are used. The second pass re-melts the first and deposits are clean and porosity free.

## PRESS FITS

Press-fit joints usually are coated with a lubricant before the parts are pressed together. The lubricant becomes a gas-producing contaminant that may cause porosity, generally in the form of large holes at or near the end of the weld. It is best to avoid press fits and allow a gap of up to  $\frac{1}{32}$ " (.8 mm). Another solution is to knurl one part so that there is a path for the gas to escape.

## POLARITY

Positive polarity is generally better than negative for reducing porosity. This is not true when welding sulfur bearing or some other steel where it is desired to reduce penetration and admixture.

## TRAVEL SPEED

Fast travel speeds on light gauge sheet tend to increase porosity because of increased arc blow (see page 3). Reducing speed and current may reduce porosity on these applications if other means of controlling arc blow are ineffective.

Actually, reducing speed will reduce porosity on any joint. Slower speeds give gaseous materials longer to boil out of the molten weld metal.

Of course, reducing welding speed generally increases costs so other solutions should be investigated first.

### Customer Assistance Policy

The business of The Lincoln Electric Company is manufacturing and selling high quality welding equipment, consumables, and cutting equipment. Our challenge is to meet the needs of our customers and to exceed their expectations. On occasion, purchasers may ask Lincoln Electric for advice or information about their use of our products. We respond to our customers based on the best information in our possession at that time. Lincoln Electric is not in a position to warrant or guarantee such advice, and assumes no liability, with respect to such information or advice. We expressly disclaim any warranty of any kind, including any warranty of fitness for any customer's particular purpose, with respect to such information or advice. As a matter of practical consideration, we also cannot assume any responsibility for updating or correcting any such information or advice once it has been given, nor does the provision of information or advice create, expand or alter any warranty with respect to the sale of our products.

Lincoln Electric is a responsive manufacturer, but the selection and use of specific products sold by Lincoln Electric is solely within the control of, and remains the sole responsibility of the customer. Many variables beyond the control of Lincoln Electric affect the results obtained in applying these type of fabrication methods and service requirements.

**LINCOLN**  
**ELECTRIC**

## Storing and Redrying Submerged Arc Welding Fluxes

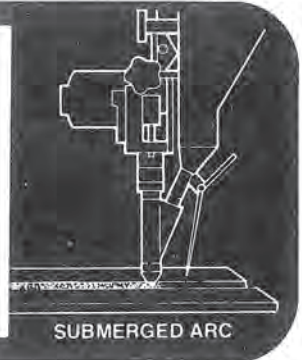

Submerged arc welding fluxes and other low hydrogen welding products must be dry to perform properly.

Lincoln agglomerated fluxes in their original unopened bags will remain dry in good storage conditions.

When the bags are opened or punctured, remove the flux and store it in closed containers in a dry area. Lincoln submerged arc fluxes *do not* pick up moisture from the air. However, moisture contamination of exposed flux can occur by simple condensation of moisture from the surrounding air. This condensation of moisture also occurs on steel plate and everything else stored in the same location. Condensation is especially severe under humid conditions when the air temperature drops (usually after sundown).

When opened bags are exposed to air for a few days or when sealed bags are stored in unusually damp conditions, the flux may experience contamination by condensed moisture. Depending on the amount of moisture, weld quality can be damaged as follows:

1. Moisture reduces the ability of this low hydrogen welding process to resist underbead cracking on hardenable base steel.
2. Moisture may cause internal porosity. Detecting the porosity may require x-ray inspection or destructive testing.
3. A relatively high moisture content causes visible external porosity in addition to internal porosity. It may also cause excessive slag fluidity, a rough weld surface and difficult slag removal.
4. Severe moisture contamination can cause weld cracks, underbead cracking, severe porosity, poor appearance and slag problems.

To redry flux, heat in an appropriate container to a minimum temperature of 500°F and hold the mass long enough to raise the entire bulk of the flux to that temperature. Keep the entire mass at this temperature for a minimum of two hours. Severe moisture contamination may increase the time at temperature required for complete drying. Drying temperatures in excess of 900°F are not recommended.

Do not attempt to redry flux in drums or any large containers where penetration of the heat throughout the entire mass is difficult.

The following test illustrates the relative moisture resistance of Lincoln agglomerated submerged arc fluxes.

In this test a series of hydrogen evolution checks were made with Lincolnweld 860 flux (with L-61 electrode) and with  $\frac{5}{32}$ " diameter E7018 moisture resistant, low hydrogen manual electrode. The first checks were conducted with these products in the "as manufactured" condition.

These same products were also tested after humidification for one week at 85% relative humidity (@ 103°F). This extremely high humidity level was selected to maximize the severity of the test.

The humidified 860 flux and humidified E7018 moisture resistant, low hydrogen manual electrode were then redried at the temperatures indicated below. A third set of hydrogen evolution tests were conducted with these products in the redried condition.

The test data summarized below clearly illustrate the low hydrogen, moisture resistant characteristics of Lincoln agglomerated submerged arc fluxes.

### DIFFUSIBLE HYDROGEN (GLYCERINE METHOD)<sup>(1)</sup>

	Lincoln 860 Flux (with L-61 electrode)	E7018 Moisture Resistant, Low Hydrogen Electrode
As Manufactured	.011 ml/gram	.011 ml/gram
Humidified	.056 ml/gram	.230 ml/gram
Redried @ 230°F	.032 ml/gram	Not Checked
Redried @ 500°F	.018 ml/gram	.042 ml/gram
Redried @ 750°F	Not Checked	.020 ml/gram

<sup>(1)</sup> Lloyd's Register and The American Bureau of Shipping have specified that the diffusible hydrogen shall not exceed 0.1 ml. H<sub>2</sub> per gram of deposited weld metal for ordinary strength filler metals. For higher strength filler metals The American Bureau of Shipping has specified that the diffusible hydrogen shall not exceed 0.5 ml. H<sub>2</sub> per gram of deposited weld metal.

### WARNING

As noted in this bulletin, using submerged arc fluxes with improper moisture content may result in a reduction in weld quality. Many variables beyond the control of the Lincoln Electric Co. affect the results obtained in the use of redried fluxes. These variables include, but are not limited to, redry-

ing procedure, welding procedure, plate chemistry and temperature, weldment design, fabrication methods and service requirements. Therefore, the serviceability of redried fluxes and the product or structure on which they are used, is and must be the sole responsibility of the user.

**LINCOLN**  
**ELECTRIC**

## THE LINCOLN ELECTRIC COMPANY

World's Leader in Welding and Cutting Products • Premier Manufacturer of Industrial Motors

Sales and Service through Subsidiaries and Distributors Worldwide

Cleveland, Ohio 44117-1199 U.S.A.



## SECTION II.

- |                                 |        |
|---------------------------------|--------|
| 1. Tiny Twinarc®                | E9.100 |
| 2. How to Make Tandem Arc Welds | C5.640 |



# TINY TWINARC<sup>®</sup>

## A TWIN WIRE SUBMERGED ARC PROCESS

### DESCRIPTION

Tiny Twinarc<sup>®</sup> is a submerged arc welding process that uses two small diameter electrodes at high wire feed speeds. Tiny Twinarc offers substantial welding economies when used to replace a conventional single electrode for many applications. These economies result from faster travel speeds and higher usable deposit rates. The two wires in close proximity result in an elongated puddle that improves follow characteristics and enables faster travel speeds while maintaining the proper weld bead shape. The equipment consists of a power source, an automatic welding head (and controls) with dual drive rolls and guides and a common contact nozzle.

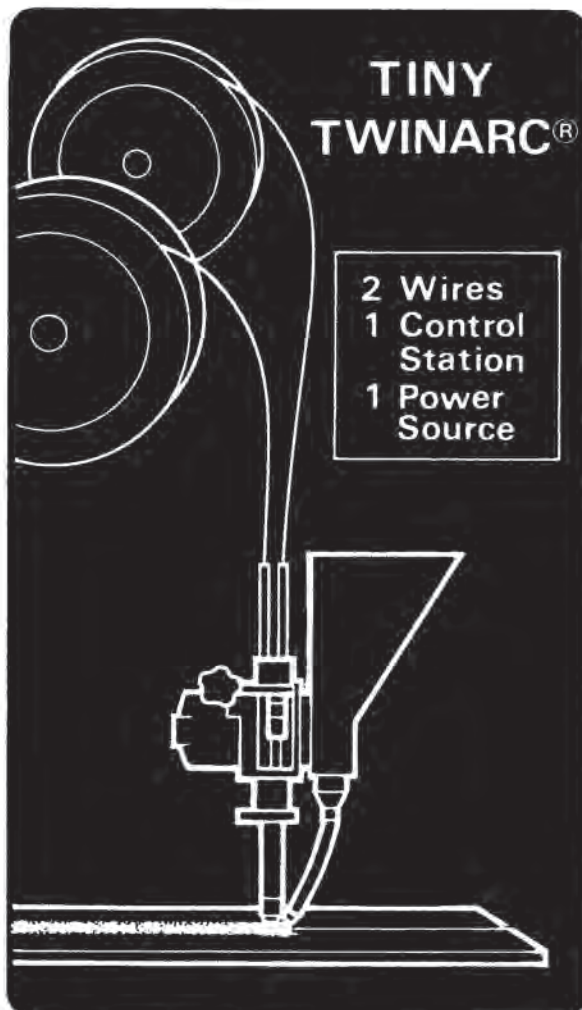

### BENEFITS

The process offers these advantages over single arc:

1. High deposition rates — increases of 40% or more are common.
2. Faster travel speeds — 25% or more on light gauge material and 50 to 75% on heavier material.
3. Lower heat input and 5 to 50% less distortion. Tiny Twinarc results in low heat input per pound of metal deposited. This aids in controlling distortion and becomes especially important when welding high impact strength steels where the HAZ impacts deteriorate with increased heat input.
4. Lower power consumption per pound of weld metal.

Tiny Twinarc is a fast, simple welding process that results in low cost fabrication with equal or better weld quality.

### APPLICATIONS

The Tiny Twinarc process has application in the manufacture of earth movers, excavators, cement mixers, railcars, code tanks and pressure vessels, thin-walled shells and many other welded products made of material ranging in thickness from 14 gauge (1.9mm) to heavy plate. This system is versatile and is readily usable on:

1. Light gauge weldments
2. Heavy weldments
3. For larger circumferential welds where high deposition rates are usable.
4. Flat fillets, horizontal fillets and lap welds
5. Butt welds, including those made in the 3 o'clock position.
6. Hardfacing applications

# DEPOSITION RATE ADVANTAGES

**Higher Current** — With the single arc process, raising the current to increase the deposition rate may result in poor bead shape, undercutting and/or excessive penetration. The Tiny Twinarc process makes the use of higher currents practical.

**Resistance Heating** — Another factor contributing to Tiny Twinarc's higher deposition rate is the high current density resistance heating effect on the smaller diameter wires.

# TRAVEL SPEED

In conventional single arc operation, it is possible to increase the travel speed by simply increasing the welding current; however, bead shape, bead appearance, undercutting, or burn-through impose a limitation on travel speed. With Tiny Twinarc, the higher usable deposition rate results in arc speed increases, while still maintaining the desirable bead shape, bead placement, penetration and other desirable welding characteristics.

# HORIZONTAL FILLETS

In the welding of horizontal fillets, Tiny Twinarc can increase travel speeds up to 68% for 1/8" through 5/16" (3.2 through 7.9mm) fillets.

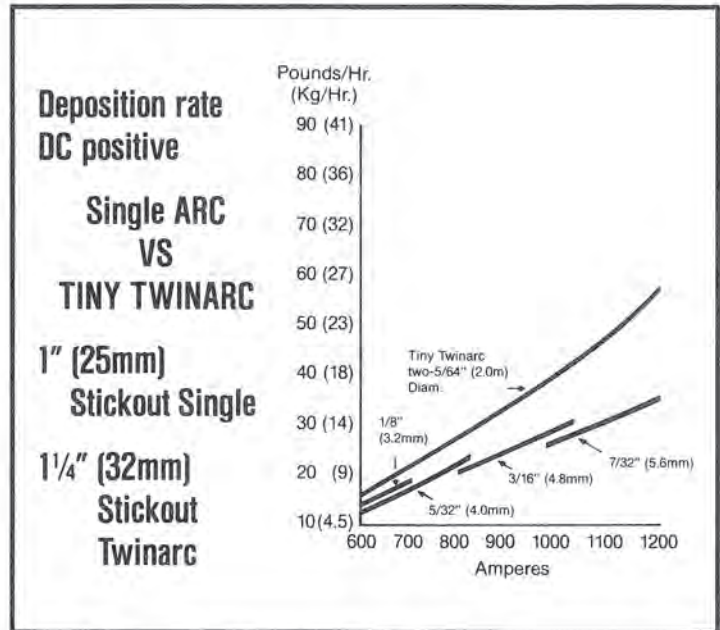
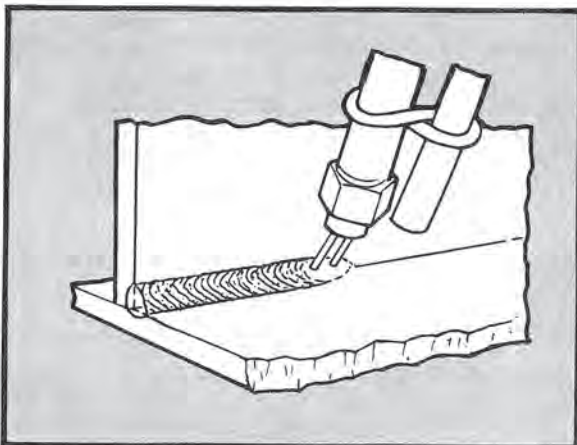

## Light Gauge Horizontal Fillets Single Arc vs. Tiny Twinarc®

SIZE	Single Arc	Tiny Twinarc®
1/8" (3.2mm)	62 ipm (1.6m/min)	100 ipm (2.5m/min)
5/32" (4.0mm)	54 ipm (1.4m/min)	85 ipm (2.2m/min)
3/16" (4.8mm)	42 ipm (1.1m/min)	70 ipm (1.8m/min)

## Horizontal Fillets Single Arc vs. Tiny Twinarc®

SIZE	Single Arc	Tiny Twinarc®
1/4" (6.4mm)	30 ipm (0.8m/min)	50 ipm (1.3m/min)
5/16" (7.9mm)	22 ipm (0.6m/min)	32 ipm (0.8m/min)

# FLAT FILLETS

Tiny Twinarc offers about a 50% increase in welding speed over single electrode in the welding of flat fillets.

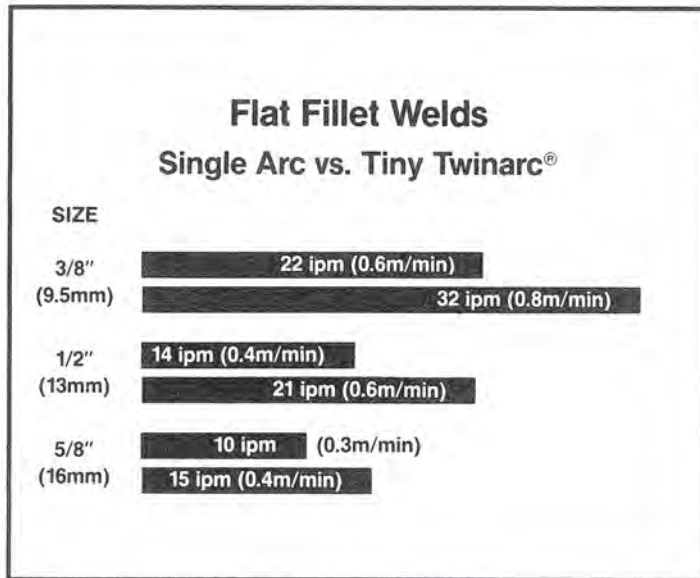

# LAP WELDS

Small lap welds made with Tiny Twinarc result in welding speed increases of 43 to 70% over single arc.

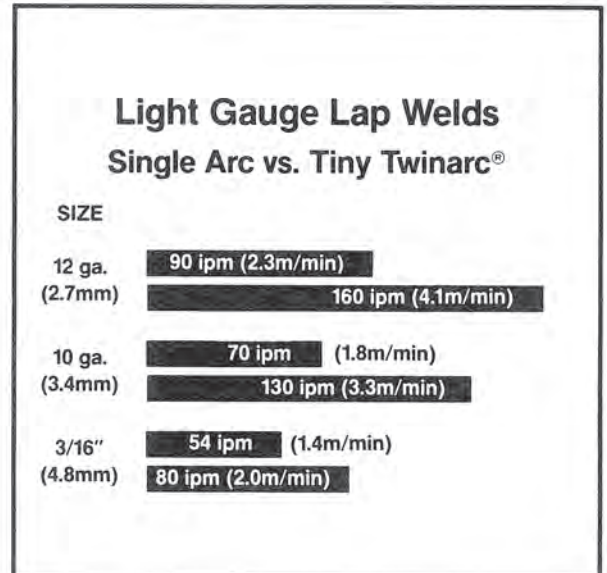

# BUTT WELDS

Tiny Twinarc can be used for prepared groove butt welds on code vessels and heavy-walled tanks. Butt welds can be made economically in the flat and 3 o'clock position. Increased speeds of 30% or more are practical.

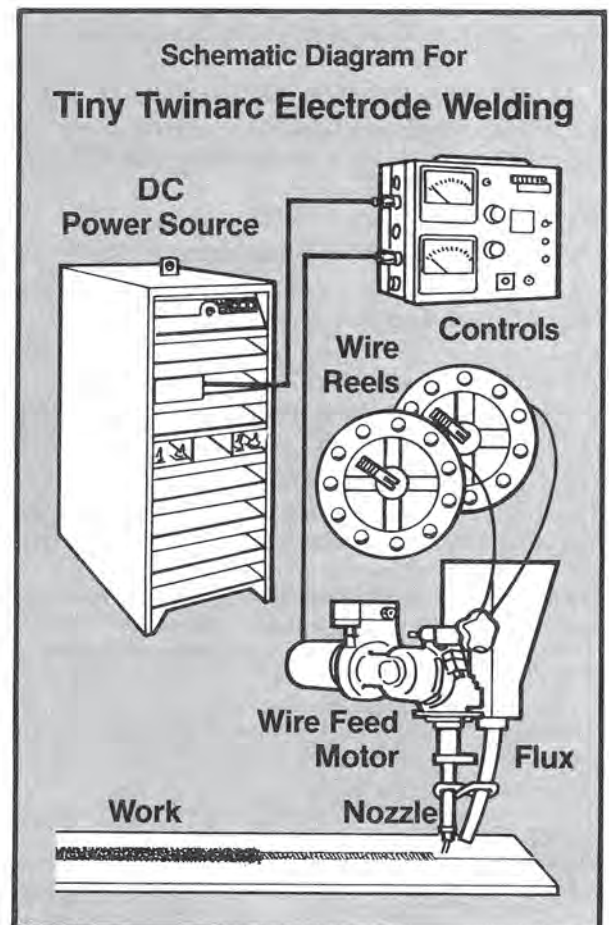
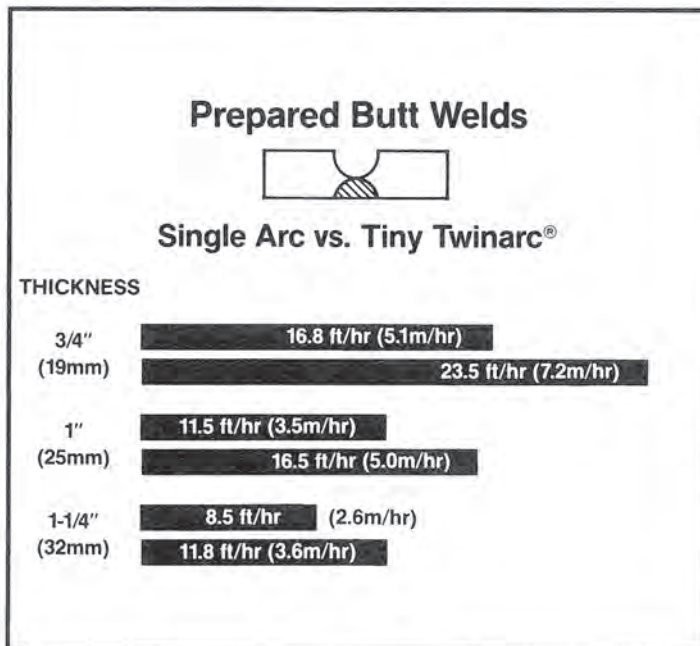



## PROCEDURE RECOMMENDATIONS

**Flux and Electrode Selection** — In general, the flux and electrode selected for Tiny Twinarc applications should be made on the same basis as that for single wire applications. See Bulletin S210 for wire and flux combinations. Consult your Lincoln Technical Representative for suggested welding procedures.

### Polarity

Electrode Positive (DC+) is recommended for:

1. Best impact strength.
2. Deepest penetration.
3. Highest Radiographic quality.
4. High speed light gauge applications where arc speed is important.
5. Improved resistance to arc blow resulting from a "stiffer" arc.

Electrode Negative (DC-) is recommended for:

1. Improved crack resistance resulting from a less crack sensitive bead shape and reduced base plate admixture.
2. High deposition rate applications where rate is the major consideration.

**Electrode Size** — The electrode diameter selected for Lincoln Tiny Twinarc procedures is the best compromise between deposition rate, bead shape, flash through, penetration, etc. The available sizes are: .045, .052, 1/16", 5/64" and 3/32" (1.1, 1.3, 1.6, 2.0, and 2.4mm) diameters.

**Constant Voltage and Constant Current Operation** — A constant voltage power source is preferred:

1. On high speed applications where speed is the prime consideration.
2. For 3/16" (4.8mm) and smaller horizontal fillets.
3. For 5/16" (7.9mm) and smaller flat fillets.

The DC-600, DC-650 PRO, DC-1000 or DC-1500 on CV sub-arc, or other power sources in the constant current mode, are preferred:

1. On high deposition rate applications.
2. For maximum penetration.

## EQUIPMENT RECOMMENDATIONS

The following equipment is recommended for new installations:<sup>(1)</sup>

1. **NA-3S or NA-5S Automatic Welding Head (95:1 gear ratio) and Control.** The solid state controls are convenient and versatile with independent adjustment of:
  - a. Inch speed.
  - b. "On the fly" or "hot" starting.
  - c. A starting circuit for control of current, voltage and timing (Optional).
  - d. Crater current, crater voltage and timing (Optional).
2. **DC-600, DC-650 PRO, DC-1000 or DC-1500 Power Source** — will perform in the constant voltage or constant current mode.  
These units feature a full range rheostat with remote control capabilities, line voltage compen-

sation and adjustable O.C.V. on constant voltage. These solid state power sources have been designed in conjunction with the Tiny Twinarc process to provide excellent and consistent results. They provide the best degree of control to facilitate procedure setting when used with NA-3 or NA-5 automatic welding systems.

3. Tiny Twinarc Contact Assembly (K129) — includes drive rolls, idler, wire reel and torch.
4. Tiny Twinarc Solid Wire Straightener (K281).
5. Power source to automatic control cable assemblies and work cables.

<sup>(1)</sup> Consult your Lincoln Representative for optional choices.

For more information on submerged arc welding see Bulletins S604, S632, S640.

The serviceability of a product or structure utilizing this type of information is and must be the sole responsibility of the builder/user. Many variables beyond the control of the Lincoln Electric Company affect the results obtained in applying this type of information. These variables include, but are not limited to, welding procedure, plate chemistry, temperature, weldment design, fabrication methods and service requirements.



## THE LINCOLN ELECTRIC COMPANY

World's Leader in Welding and Cutting Products • Premier Manufacturer of Industrial Motors

Sales and Service through Subsidiaries and Distributors Worldwide

Cleveland, Ohio 44117-1199 U.S.A.

# How to Make TANDEM ARC WELDS

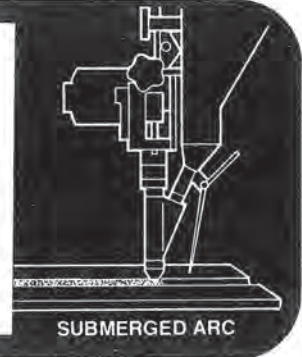

## ADVANTAGES OF TANDEM ARC WELDING

Many applications that can be successfully welded with single electrode automatic equipment can be more economically welded with tandem arc multiple electrode methods. The reason is simple. Two electrodes feeding into the same weld carry higher total currents than a single electrode. Higher total current increases deposit rates and/or speeds and reduces welding costs. Another benefit frequently gained with the tandem arc welding is reduced distortion resulting from increased welding speed.

## LIMITATIONS OF TANDEM ARC WELDING

The combination of high travel speed, larger weld puddle, more involved set-ups, and higher equipment costs make multiple arc welding impractical for the following applications:

1. Short welds and small diameter roundabouts.
2. Installations where frequent set-up changes are required.
3. Low volume jobs that will not justify equipment costs.
4. Applications for which the heat input may be limited because of the mechanical property requirements of the weld metal or heat affected zone.

### DC-AC 2 ELECTRODE TANDEM ARC

Utilizes an NA-3 or NA-5 automatic head and DC power source for the lead arc and an NA-4 automatic head and a constant current type AC power source for the trail electrode. The LT-56 tractor is recommended when maximum portability is required.

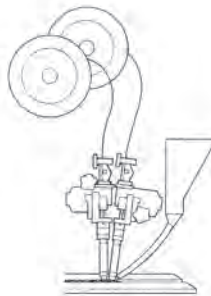

#### Advantages

1. 25% to 100% higher deposit rates and speeds than single electrode DC on a good range of applications:
  - a. Multiple pass welds.
  - b. Single pass butt welds on 10 gauge and thicker steel.
  - c. Single pass  $\frac{1}{4}$  to  $\frac{1}{2}$ " (6.4 to 12.7 mm) horizontal fillets and laps.
  - d. Single pass  $\frac{1}{4}$  to  $\frac{3}{4}$ " (6.4 to 19.1 mm) flat fillets.
  - e. Large diameter [40" (1 m) minimum] roundabouts.
2. Best choice for welding into a flat flux backing.
3. Electrode spacing and controls easy to set for new applications.
4. Linc-Fill™ long stickout techniques increase deposit rates and both travel and wire feed speeds.

### DC-AC-AC 3 ELECTRODE TANDEM ARC

Utilizes an NA-3 or NA-5 automatic head and a DC power source for the lead arc and two NA-4 automatic heads and two constant current Scott connected<sup>(1)</sup> type AC power sources for the trail electrodes.

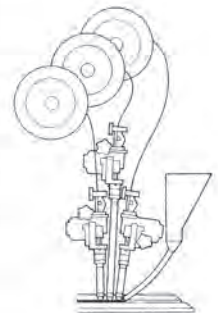

#### Advantages

1. Higher arc speeds and deposit rates than two electrode DC-AC tandem arc on a more limited range of applications:
  - a. Multiple pass welds.
  - b.  $\frac{5}{16}$  to  $\frac{1}{2}$ " (7.9 to 12.7 mm) horizontal fillets and laps.
  - c.  $\frac{1}{2}$  to  $\frac{3}{4}$ " (12.7 to 19.1 mm) flat fillets.
  - d. Single pass butt welds [example: fabricating  $\frac{3}{8}$ " (9.5 mm) pipe at 125"/min. (3.2 m/min.)].
2. Once electrode spacing and control settings are determined, repeat welds are easy to make.
3. The long puddle minimizes porosity tendencies.

<sup>(1)</sup> AC-1200 power sources have Scott connection taps factory installed for easy conversion to DC-AC-AC welding.

## EFFECTS OF OPERATING VARIABLES

The effects of operating variables described in bulletin S604 for single electrode submerged arc welding also apply to tandem arc welding. However, because tandem arc involves two or three arcs welding in the same puddle, special considerations are needed to control the interaction of the arcs for good weld quality.

The DC lead arc polarity, current, voltage, travel speed, and wire size are selected to control penetration and weld size. The variables of the AC trail arcs are selected to fill the bead to the desired size and to produce the proper bead shape and appearance.

With the DC-AC-AC three arc system the trail (AC) electrode is usually the same size or smaller than the middle (AC) wire, and it operates at the same or lower currents, higher voltages, and the same electrode spacing.

### FIXTURING

When designing and building fixtures for tandem arc welding, allowance must be made to permit adjusting electrode angles and spacing to determine the ideal conditions for the application. The heads must be rigidly mounted to maintain the correct positions during production welding.

### POLARITY

Use DC(+) lead arc polarity for maximum penetration. Use DC(-) for higher deposit rates and less penetration.

AC is recommended for the trail arcs to minimize the arc blow interaction between the arcs for easier setup and welding.

### CURRENT

Use a higher DC current lead arc for maximum deposit rates consistent with desired penetration.

Use sufficient current for the AC trail arcs to fill the bead to the desired size and eliminate undercut. Excessive current results in wavy edges.

### VOLTAGE

Use low voltage on the DC lead arc, particularly in the V-butt joints, for a stiff deep penetrating arc. Increasing the voltage increases bead width. Excessive voltage produces wavy edges.

Adjust AC trail voltages for proper bead shape and width, 35 to 42 volts may be required for good wash-in particularly on the third arc. Excessive voltage causes undercutting.

### TRAVEL SPEED

Fast travel speeds produce low penetration and a narrow bead. Excessive speed results in undercut.

Excessive slow speed allows weld metal to wash under the lead arc causing an erratic arc and "rollover" along the edges of the bead.

### ELECTRODE SIZE

Either  $\frac{5}{32}$  or  $\frac{3}{16}$ " (4.0 or 4.8 mm) electrode is recommended for the lead arc in most applications. Use the  $\frac{5}{32}$ " (4.0 mm) size for deep penetration. The trail arc electrodes are usually smaller than the lead arc electrode because they carry less current.

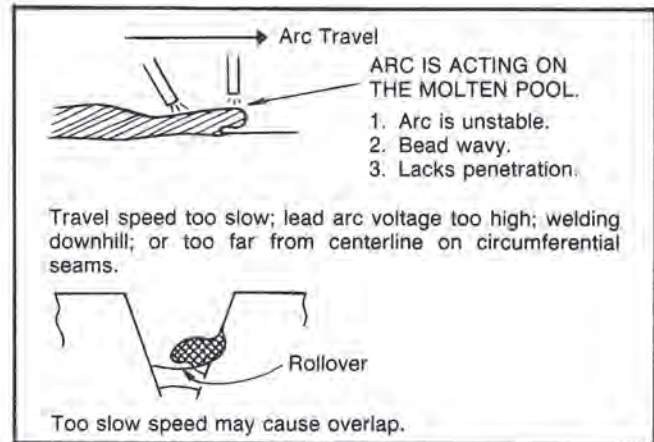

### FLUX & ELECTRODE SELECTION

Basically, the flux and electrode is selected for tandem arc welding for the same reasons it is selected for single arc automatic welding.

The 761 or 780 and L-61 combination is recommended for most single pass applications. For high speed welding [over 60 in./min (1.5 m/min.)], 761 and L-61 are recommended. 781 and L-61 may also be used. For multiple pass welds on plate over 1" (25.4 mm) thick, 860 and L-61 or 980 and L-50 should usually be used.

Lincolnweld® 985 and 995 flux are recommended for square butt welding applications requiring one pass per side. 985 flux is designed for use with Lincoln L-50 or LA-90 electrodes. 995 flux is designed for use with Lincoln L-70 electrode. These fluxes produce welds with minimal buildup and good penetration.

When best resistance to nitrogen porosity and optimum impact resistance are required on multiple pass welds, use 880M flux or MIL 800 flux with L-50.

### FLUX DEPTH

Deposit flux deep enough that the trail arc occasionally flashes through. Excessively deep flux results in a narrow rough bead.

Deposit the flux about 2" (51 mm) in front of the lead arc so the flux acts as a mechanical trap preventing slag and weld metal from flowing forward to interfere with the arcs.

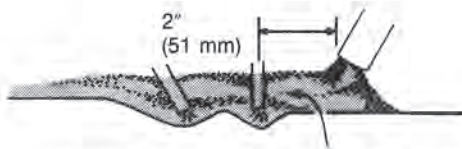

This flux is acting as a dam holding both slag and metal from flowing ahead.

## ELECTRODE SPACING

A  $\frac{5}{8}$  to  $\frac{7}{8}$ " (15.9 to 22.2 mm) spacing between electrodes is recommended. Closer spacing produces narrow beads and deep penetration, while wider spacing reduces penetration and widens the bead. Spacing also affects arc stability. Reduce spacing to eliminate trail arc instability caused by shorting on the molten pool and increase spacing to eliminate lead arc instability caused by molten metal or slag running under the arc.

Horizontal fillets with  $\frac{3}{8}$ " (9.5 mm) and larger leg size are made with a spacing of 3" (76.2 mm) or more. These are more like three pass welds than tandem arc welds. With this wide spacing, a DC-AC-DC combination may provide a more stable third arc than the DC-AC-AC combination recommended for most applications.

## ELECTRODE STICKOUT

Normal stickout of the electrode between the nozzle contact tip and the work starts at about  $\frac{3}{4}$ " (6.4 mm) for small welds and increases to about 2" (51 mm) for large welds.

# SPECIAL CONSIDERATIONS FOR DEEP GROOVE WELDING

## JOINT PREPARATION

1. Typical joints are shown in the sketches. Total bevels should never be less than  $7^\circ$  after the plates have pulled together due to the contraction. Smaller bevels undercut and trap slag. Larger bevel angles waste weld metal.

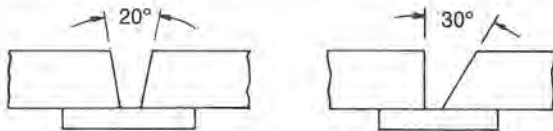

2. Run-off tabs are required for most jobs except roundabouts. Tabs should be used at both ends and should be shaped like the joint. Make them heavy enough to ensure minimum arc disturbance and weld them to both sides of the joint and the back-up bar, if one is used. Close the finish end to provide a magnetic path to reduce arc blow.

## ALIGNMENT

Accurate alignment is extremely important. Check the following:

1. The seam should be aligned with the welding heads' line of travel so adjustments during welding are unnecessary.
2. The work should be level across the seam and level along the length of the joint.
3. Space electrodes away from the wall of the groove a distance about equal to the width of the larger wire. Provide

Linc-Fill™ long stickout procedures increase deposition rates and reduce costs for large welds on heavy plate. The K148 nozzle equipped with a K149 Linc-Fill extension is required for proper electrode alignment with the joint.

## ELECTRODE ALIGNMENT

For even edges on most welds, the electrodes must be in line. This must be maintained within  $\frac{1}{32}$ " (0.8 mm). However, on horizontal fillet welds a small variation may be needed to maintain the leg size on the vertical plate.

## NOZZLES

Clamp the nozzles together with an insulated clamp to help maintain electrode alignment and spacing. Worn nozzle contact tips cause misalignment and erratic contact. Replace worn contact tips promptly.

## WORK CONNECTION

The location of the work lead connection to the work is particularly important on short welds. Connect both AC and DC work leads at the start of the weld. However, if back blow is desired to help keep metal from running ahead of the arc, weld toward the work lead connection.

a horizontal adjustment on the welding heads so they can be moved across the joint for alignment.

4. Maintain a constant electrode stickout for all passes. To do this either raise the heads or lower the work after each pass.

## PREHEAT

Must be determined on the basis of the base metal chemistry and plate thickness. Governing codes must also be met.

1. Use the Lincoln Preheat Calculator to estimate preheat and interpass temperature.
2. Preheat the entire piece if possible.
3. Allow the plate to cool slowly after welding. Heat-treat if required.

Preheat and interpass temperature control are recommended for optimum mechanical properties, crack resistance and hardness control. This is particularly important on multiple pass welds and heavier plate. Job conditions, prevailing codes, high restraint, alloy level and other considerations may also require preheat and interpass temperature control.

## ROOT PASSES

Single arc, DC(+) welds are recommended for the first few passes to get adequate penetration. If arc blow is a serious problem, make these root passes with a single arc AC.

## BEAD SHAPE

Beads should be slightly convex to prevent longitudinal cracking. Deposit split beads that are nearly flat rather than steep fillets on the sidewalls of the joint.

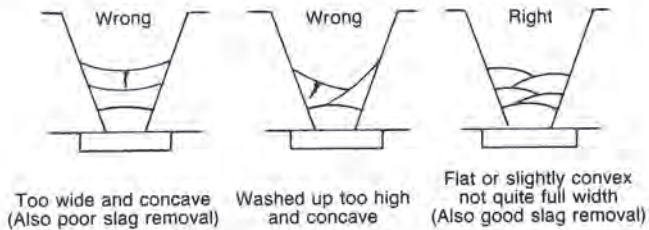

## CONTROL OF MOLTEN METAL

Molten flux and metal must not run ahead of the arc. The following is a summary of the methods used to control the molten pool:

1. Increase electrode spacing slightly.
2. Increase travel speed.
3. Weld slightly ( $2^\circ$ ) uphill — not downhill.
4. Do not start on high spot at the start of the previous bead.
5. Use proper alignment.
6. Use a fairly low voltage on the lead arc and/or low trail arc current.

The serviceability of a product or structure utilizing this type of information is and must be the sole responsibility of the builder/user. Many variables beyond the control of The Lincoln Electric Company affect the results obtained in applying this type of information. These variables include, but are not limited to, welding procedure, plate chemistry and temperature, weldment design, fabrication methods and service requirements.



**THE  
LINCOLN ELECTRIC  
COMPANY**

Local Sales and Service through Global  
Subsidiaries and Distributors  
Cleveland, Ohio 44117-1199 U.S.A  
TEL: 216.481.8100  
FAX: 216.486.1751  
WEB SITE: [www.lincolnelectric.com](http://www.lincolnelectric.com)

**Submerged Arc  
C5.640 2/98**

*DISTRIBUTED BY:*

